



VistA Imaging System
DICOM Conformance Statement

August 2011 – Revision 6

Department of Veterans Affairs
Office of Enterprise Development
Health Provider Systems

VistA Imaging DICOM Conformance Statement
VistA Imaging 3.0
Aug 2011

Property of the US Government

This is a controlled document. No changes to this document may be made without the express written consent of the VistA Imaging development office.

While every effort has been made to assure the accuracy of the information provided, this document may include technical inaccuracies and/or typographical errors. Changes are periodically made to the information herein and incorporated into new editions of this document.

Product names mentioned in this document may be trademarks or registered trademarks of their respective companies, and are hereby acknowledged.

VistA Imaging Office of Enterprise Development
Department of Veterans Affairs
Internet: <http://www.va.gov/imaging>
VDL documents: <http://www.va.gov/vdl/application.asp?appid=105>

OVERVIEW

VistA is the Hospital Information System (HIS) developed by the Department of Veterans Affairs. VistA is used by clinical staff in every phase of the healthcare delivery process. VistA Imaging is the image-enabling component of the VistA HIS.

Network Services/SOP Class Summary

VistA Imaging supports the Networking DICOM Service (SOP) Classes listed below.

Table 1-1: Supported Network Services/SOP Classes

SOP Class Name	SOP Class UID	SCU	SCP
Verification			
Verification SOP Class	1.2.840.10008.1.1	Yes	Yes
Transfer			
Computed Radiography Image Storage	1.2.840.10008.5.1.4.1.1.1	Yes	Yes
Digital X-Ray Image Storage - For Presentation	1.2.840.10008.5.1.4.1.1.1.1	Yes	Yes
Digital X-Ray Image Storage - For Processing	1.2.840.10008.5.1.4.1.1.1.1.1	Yes	Yes
Digital Mammography X-Ray Image Storage - For Presentation	1.2.840.10008.5.1.4.1.1.1.2	Yes	Yes
Digital Mammography X-Ray Image Storage - For Processing	1.2.840.10008.5.1.4.1.1.1.2.1	Yes	Yes
Digital Intra-oral X-Ray Image Storage – For Presentation	1.2.840.10008.5.1.4.1.1.1.3	Yes	Yes
Digital Intra-oral X-Ray Image Storage – For Processing	1.2.840.10008.5.1.4.1.1.1.3.1	Yes	Yes
CT Image Storage	1.2.840.10008.5.1.4.1.1.2	Yes	Yes
Ultrasound Multi-frame Image Storage (Retired)	1.2.840.10008.5.1.4.1.1.3	Yes	Yes
Ultrasound Multi-frame Image Storage	1.2.840.10008.5.1.4.1.1.3.1	Yes	Yes
MR Image Storage	1.2.840.10008.5.1.4.1.1.4	Yes	Yes
Nuclear Medicine Image Storage (Retired)	1.2.840.10008.5.1.4.1.1.5	Yes	Yes
Ultrasound Image Storage (Retired)	1.2.840.10008.5.1.4.1.1.6	Yes	Yes
Ultrasound Image Storage	1.2.840.10008.5.1.4.1.1.6.1	Yes	Yes
Secondary Capture Image Storage	1.2.840.10008.5.1.4.1.1.7	Yes	Yes
Multi-frame Grayscale Byte Secondary Capture Image Storage	1.2.840.10008.5.1.4.1.1.7.2	Yes	Yes
Multi-frame Grayscale Word Secondary Capture Image Storage	1.2.840.10008.5.1.4.1.1.7.3	Yes	Yes

OVERVIEW

SOP Class Name	SOP Class UID	SCU	SCP
Multi-frame True Color Secondary Capture Image Storage	1.2.840.10008.5.1.4.1.1.7.4	Yes	Yes
X-Ray Angiographic Image Storage	1.2.840.10008.5.1.4.1.1.12.1	Yes	Yes
X-Ray Radiofluoroscopic Image Storage	1.2.840.10008.5.1.4.1.1.12.2	Yes	Yes
Nuclear Medicine Image Storage	1.2.840.10008.5.1.4.1.1.20	Yes	Yes
VL Image Storage (Retired)	1.2.840.10008.5.1.4.1.1.77.1	Yes	Yes
VL Endoscopic Image Storage	1.2.840.10008.5.1.4.1.1.77.1.1	Yes	Yes
VL Microscopic Image Storage	1.2.840.10008.5.1.4.1.1.77.1.2	Yes	Yes
VL Slide-Coordinates Microscopic Image Storage	1.2.840.10008.5.1.4.1.1.77.1.3	Yes	Yes
VL Photographic Image Storage	1.2.840.10008.5.1.4.1.1.77.1.4	Yes	Yes
Ophthalmic Photography 8 Bit Image Storage	1.2.840.10008.5.1.4.1.1.77.1.5.1	Yes	Yes
Ophthalmic Photography 16 Bit Image Storage	1.2.840.10008.5.1.4.1.1.77.1.5.2	Yes	Yes
VL Multi-frame Image Storage (Retired)	1.2.840.10008.5.1.4.1.1.77.2	Yes	Yes
Encapsulated PDF Storage SOP Class	1.2.840.10008.5.1.4.1.1.104.1	Yes	Yes
Positron Emission Tomography Image Storage	1.2.840.10008.5.1.4.1.1.128	Yes	Yes
RT Image Storage	1.2.840.10008.5.1.4.1.1.481.1	Yes	Yes
Query/Retrieve			
Study Root Query/Retrieve Information Model - FIND	1.2.840.10008.5.1.4.1.2.2.1	Yes	Yes
Study Root Query/Retrieve Information Model - MOVE	1.2.840.10008.5.1.4.1.2.2.2	Yes	Yes
Workflow Management			
Modality Worklist Information Model - FIND	1.2.840.10008.5.1.4.31	Yes	Yes
Print Management			
Not supported			
Notes, Reports, Measurements Transfer			
VA Detached Patient Management (Retired)	1.2.840.113754.3.1.2.1.1	No	Yes
VA Detached Patient Management Meta SOP Class (Retired)	1.2.840.113754.3.1.2.1.4	No	Yes
VA Detached Visit Management SCP (Retired)	1.2.840.113754.3.1.2.2.1	No	Yes
VA Detached Study Management SCP (Retired)	1.2.840.113754.3.1.2.3.1	No	Yes
VA Detached Study Component Management (Retired)	1.2.840.113754.3.1.2.3.2	No	Yes

SOP Class Name	SOP Class UID	SCU	SCP
VA Detached Results Management SOP Class (Retired)	1.2.840.113754.3.1.2.5.1	No	Yes
VA Detached Results Management Meta SOP Class (Retired)	1.2.840.113754.3.1.2.5.4	No	Yes
VA Detached Study Management Meta SOP Class (Retired)	1.2.840.113754.3.1.2.5.5	No	Yes
VA Detached Interpretation Management SCP (Retired)	1.2.840.113754.3.1.2.6.1	No	Yes

Media Services Summary

VistA Imaging supports the Media Storage Application Profiles and roles listed below.

Table 1-2: Supported Media Services

Media Storage Application Profile	Write Files (FSC or FSU)	Read Files (FSR)
Compact Disk - Recordable		
General Purpose CD-R Interchange	No ¹	Yes
DVD		
General Purpose DVD-RAM	No ¹	Yes

¹ In the VA, commercial products are used to create DICOM-formatted portable media.

OVERVIEW

CONTENTS

OVERVIEW.....	III
Network Services/SOP Class Summary.....	iii
Media Services Summary.....	v
TABLES	XII
FIGURES.....	XIII
1 INTRODUCTION	1
1.1 Revision History.....	1
1.2 Audience	2
1.3 Remarks	2
1.4 Terms and Definitions	2
1.5 Basics of DICOM Communication	5
1.6 Abbreviations.....	5
1.7 References	7
2 NETWORKING.....	9
2.1 Implementation Model.....	9
2.1.1 Application Data Flow	9
2.1.2 Functional Definitions of Local Application Entities	12
2.1.2.1 Storage-SCP	12
2.1.2.2 Storage-SCU	12
2.1.2.3 Modality-Worklist-SCP	12
2.1.2.4 Modality-Worklist-SCU.....	12
2.1.2.5 Query/Retrieve-SCP	12
2.1.2.5 Query/Retrieve-SCU	13
2.1.2.6 Verification SCU/SCP	13
2.1.2.7 VistA VA Detached Patient/Study/Result management SCP (retired)	13
2.1.3 Sequencing of Real World Activities	13
2.1.3.1 Real World Events and Message Sequence Relationship--Radiology	14
2.1.3.1.1 Patient Registration/Patient Demographic Change and Admission/Discharge/Transfer 14	
2.1.3.1.2 Order Entry	14
2.1.3.1.3 Order Update.....	14
2.1.3.1.4 Patient Registration (Radiology)	15
2.1.3.1.5 Exam Verification	15
2.1.3.1.6 Report Dictated/Transcribed.....	16
2.1.3.1.7 Report Verified.....	16
2.1.3.2 Real World Events and Message Sequence Relationship—Clinical Specialties	17
2.1.3.2.1 CPRS Order Entry.....	17
2.1.3.2.2 CPRS Pre-visit Actions.....	17
2.1.3.2.3 Clinical Specialty Appointment Scheduling	17
2.1.3.2.4 Clinical Specialty Patient Arrival	17
2.1.3.2.5 Clinical Specialty Image Acquisition	17
2.1.3.2.6 Clinical Specialty Completion	18
2.1.3.2.7 Clinical Specialty Follow-up Visits.....	18
2.2 AE Specifications.....	18

CONTENTS

- 2.2.1 Storage-SCP AE Specification 18
 - 2.2.1.1 SOP Classes 18
 - 2.2.1.2 Association Policies 20
 - 2.2.1.2.1 General 20
 - 2.2.1.2.2 Number of Associations 20
 - 2.2.1.2.3 Asynchronous Nature 20
 - 2.2.1.2.4 Implementation Identifying Information 20
 - 2.2.1.3 Association Initiation Policy 20
 - 2.2.1.4 Association Acceptance Policy 21
 - 2.2.1.4.1 Activity – Receive Storage Request 21
 - 2.2.1.4.1.1 Description and Sequencing of Activities 21
 - 2.2.1.4.1.2 Accepted Presentation Contexts 21
 - 2.2.1.4.1.3 SOP Specific Conformance: Storage SOP Classes 25
- 2.2.2 Storage-SCU AE Specification 26
 - 2.2.2.1 SOP Classes 26
 - 2.2.2.2 Association Policies 27
 - 2.2.2.2.1 General 27
 - 2.2.2.2.2 Number of Associations 28
 - 2.2.2.2.3 Asynchronous Nature 28
 - 2.2.2.2.4 Implementation Identifying Information 28
 - 2.2.2.3 Association Initiation Policy 28
 - 2.2.2.3.1 Activity – Transmit Images 28
 - 2.2.2.3.1.1 Description and Sequencing of Activities 28
 - 2.2.2.3.1.2 Proposed Presentation Contexts 29
 - 2.2.2.3.1.3 SOP Specific Conformance: Storage SOP Classes 33
 - 2.2.2.4 Association Acceptance Policy 34
- 2.2.3 Modality-Worklist-SCP AE Specification 34
 - 2.2.3.1 SOP Classes 34
 - 2.2.3.2 Association Policies 34
 - 2.2.3.2.1 General 34
 - 2.2.3.2.2 Number of Associations 34
 - 2.2.3.2.3 Asynchronous Nature 35
 - 2.2.3.2.4 Implementation Identifying Information 35
 - 2.2.3.3 Association Initiation Policy 35
 - 2.2.3.4 Association Acceptance Policy 35
 - 2.2.3.4.1 Activity – Receive and Respond to Modality Worklist Query 35
 - 2.2.3.4.1.1 Description and Sequencing of Events 35
 - 2.2.3.4.1.2 Accepted Presentation Contexts 36
 - 2.2.3.4.1.3 SOP Specific Conformance: Modality Worklist Information Model – FIND 36
- 2.2.4 Modality-Worklist-SCU AE Specification 43
 - 2.2.4.1 SOP Classes 43
 - 2.2.4.2 Association Policies 43
 - 2.2.4.2.1 General 43
 - 2.2.4.2.2 Number of Associations 43
 - 2.2.4.2.3 Asynchronous Nature 43
 - 2.2.4.2.4 Implementation Identifying Information 43
 - 2.2.4.3 Association Initiation Policy 44
 - 2.2.4.3.1 Activity—Issue Modality Worklist Query 44
 - 2.2.4.3.1.1 Description and Sequencing of Activities 44
 - 2.2.4.3.1.2 Proposed Presentation Contexts 44
 - 2.2.4.3.1.3 SOP Specific Conformance: Modality Worklist SOP Class 45
 - 2.2.4.4 Association Acceptance Policy 48

2.2.5	Query/Retrieve-SCP AE Specification	49
2.2.5.1	SOP Classes	49
2.2.5.2	Association Establishment Policies	49
2.2.5.2.1	General.....	49
2.2.5.2.2	Number of Associations	49
2.2.5.2.3	Asynchronous Nature.....	50
2.2.5.2.4	Implementation Identifying Information	50
2.2.5.3	Association Initiation Policy.....	50
2.2.5.4	Association Acceptance Policy.....	50
2.2.5.4.1	Activity – Handling Query and Retrieval Requests	50
2.2.5.4.1.1	Description and Sequencing of Activity	50
2.2.5.4.1.2	Accepted Presentation Contexts	53
2.2.5.4.1.3	SOP Specific Conformance: Query SOP Classes	53
2.2.5.4.1.4	SOP Specific Conformance: Retrieval SOP Classes	55
2.2.6	Query/Retrieve-SCU AE Specification	57
2.2.6.1	SOP Classes	57
2.2.6.2	Association Establishment Policies	57
2.2.6.2.1	General.....	57
2.2.6.2.2	Number of Associations	57
2.2.6.2.3	Asynchronous Nature.....	57
2.2.6.2.4	Implementation Identifying Information	58
2.2.6.3	Association Initiation Policy.....	58
2.2.6.3.1	Activity—User-Initiated FIND Request.....	58
2.2.6.3.1.1	Description and Sequencing of Events.....	58
2.2.6.3.1.2	Proposed Presentation Contexts.....	59
2.2.6.3.2	Activity—Examination Complete Message Detected.....	60
2.2.6.3.2.1	Description and Sequencing of Events.....	60
2.2.6.3.2.2	Presentation Contexts.....	61
2.2.6.4	Association Acceptance Policy.....	63
2.2.7	Verification AE Specification.....	63
2.2.7.1	SOP Classes	63
2.2.7.2	Association Policies	63
2.2.7.2.1	General.....	63
2.2.7.2.2	Number of Associations	63
2.2.7.2.3	Asynchronous Nature.....	63
2.2.7.2.4	Implementation Identifying Information	64
2.2.7.3	Association Initiation Policy.....	64
2.2.7.3.1	Activity – Send C-ECHO Request.....	64
2.2.7.3.1.1	Description and Sequencing of Activities.....	64
2.2.7.3.1.2	Proposed Presentation Contexts.....	64
2.2.7.3.1.3	SOP Specific Conformance: Verification SOP Class	64
2.2.7.4	Association Acceptance Policy.....	65
2.2.7.4.1	Activity – Receive C-ECHO Request.....	65
2.2.7.4.1.1	Description and Sequencing of Activities.....	65
2.2.7.4.1.2	Accepted Presentation Contexts	65
2.2.7.4.1.3	SOP Specific Conformance: Verification SOP Class	65
2.2.8	Vista Imaging PACS Text Interface AE Specification (Retired).....	65
2.2.8.1	Association Establishment Policies	66
2.2.8.2	Association Acceptance Policy.....	66
2.2.8.2.1	Real-World Activity Interface initialization	66
2.2.8.2.1.1	Associated Real-World Activity	66
2.2.8.2.1.2	Presentation Context Table.....	67

CONTENTS

2.2.8.2.1.3	Presentation Context Acceptance Criterion	81
2.2.8.2.1.4	Transfer Syntax Selection Policies	81
2.2.8.3	Extensions/Specializations/Privatizations	81
2.2.8.3.1	Detached Management SOP class extension	81
2.2.8.3.1.1	Passing PID Information with each N-EVENT-REPORT transaction.....	81
2.2.8.3.1.2	Report Transfer Issues	81
2.2.8.3.1.3	Passing PID Information with the N-CREATE transaction.....	81
2.2.8.3.1.4	Passing Physicians and Institutional Locations.....	81
2.2.8.3.1.5	Passing Image Type	82
2.2.8.3.1.6	Private Sequences.....	82
2.2.8.3.1.7	Message Priority and Message Handle.....	84
2.2.8.3.1.8	Owner of Private Elements	85
2.3	Network Interfaces	85
2.3.1	Physical Network Interface	85
2.3.2	Additional Protocols	85
2.3.2.1	DHCP	85
2.3.2.2	DNS	86
2.3.3	IPv4 and IPv6 Support	86
2.4	Configuration	86
2.4.1	AE Title/Presentation Address Mapping	87
2.4.1.1	Local AE Titles.....	87
2.4.1.2	Remote AE Titles.....	88
2.4.1.2.1	Remote SCPs.....	88
2.4.2	Parameters	88
3	MEDIA INTERCHANGE	90
3.1	Implementation Model.....	90
3.1.1	Application Data Flow	90
3.1.2	Functional Definitions of AEs.....	90
3.1.2.1	Functional Definition of VistA-Imaging-FSR.....	90
3.1.3	Sequencing of Real-World Activities	90
3.1.4	File Meta Information for Implementation Class and Version.....	90
3.2	AE Specifications.....	91
3.2.1	VistA-Imaging-FSR Specification.....	91
3.2.1.1	File Meta Information for the AE.....	91
3.2.1.2	Real World Activities	91
3.2.1.2.1	Activity – Import media file.....	91
3.2.1.2.1.1	Media Storage Application Profiles.....	92
3.2.1.2.1.2	Application Profile Specific Conformance.....	96
3.3	Augmented and Private Application Profiles	96
3.4	Media Configuration.....	96
4	SUPPORT OF CHARACTER SETS.....	97
5	SECURITY.....	99
5.1	Security Profiles.....	99

5.2 Association-level Security99
5.3 Application-level Security99
ANNEXES.....101

TABLES

Table 1-1: Supported Network Services/SOP Classes iii

Table 1-2: Supported Media Services v

Table 2-1: PACS Interface Messages 13

Table 2-2: Storage-SCP: Supported SOP Classes 18

Table 2-3: Storage-SCP: DICOM Application Context 20

Table 2-4: Storage-SCP: Number of Associations Accepted 20

Table 2-5: Storage-SCP: Asynchronous Nature 20

Table 2-6: Storage-SCP: DICOM Implementation Class and Version 20

Table 2-7: Storage-SCP: Accepted Presentation Contexts 22

Table 2-8: Storage-SCP: C-STORE Response Status 26

Table 2-9: Storage-SCU: Supported SOP Classes 26

Table 2-10: Storage-SCU: DICOM Application Context 28

Table 2-11: Storage-SCU: Number of Associations Accepted 28

Table 2-12: Storage-SCU: Asynchronous Nature 28

Table 2-13: Storage-SCU: DICOM Implementation Class and Version 28

Table 2-14: Storage-SCU: Proposed Presentation Contexts 29

Table 2-15: Storage-SCU: C-STORE Response Status 33

Table 2-16: Modality-Worklist-SCP: Supported SOP Classes 34

Table 2-17: Modality-Worklist-SCP: DICOM Application Context 34

Table 2-18: Modality-Worklist-SCP: Number of Associations Accepted 34

Table 2-19: Modality-Worklist-SCP: Asynchronous Nature 35

Table 2-20: Modality-Worklist-SCP: DICOM Implementation Class and Version 35

Table 2-21: Modality-Worklist-SCP: Accepted Presentation Contexts 36

Table 2-22: Modality-Worklist-SCP: Attributes for the Modality Worklist Information Model 39

Table 2-23: Modality-Worklist-SCP: C-FIND Response Status 42

Table 2-24: Modality-Worklist-SCU: Supported SOP Classes 43

Table 2-25: Modality-Worklist-SCU: DICOM Application Context 43

Table 2-26: Modality-Worklist-SCU: Number of Associations Accepted 43

Table 2-27: Modality-Worklist-SCU: Asynchronous Nature 43

Table 2-28: Modality-Worklist-SCU: DICOM Implementation Class and Version 44

Table 2-29: Modality-Worklist-SCU: Proposed Presentation Contexts 44

Table 2-30: Modality-Worklist-SCU: Attributes for the Modality Worklist Query 45

Table 2-31: Modality-Worklist-SCU: C-FIND Response Handling 48

Table 2-32: Modality-Worklist-SCU: Communication Failure Behavior 48

Table 2-33: Query/Retrieve-SCP: Supported SOP Classes 49

Table 2-34: Query/Retrieve-SCP: DICOM Application Context 49

Table 2-35: Query/Retrieve-SCP: Number of Associations Accepted 49

Table 2-36: Query/Retrieve-SCP: Asynchronous Nature 50

Table 2-37: Query/Retrieve-SCP: DICOM Implementation Class and Version 50

Table 2-38: Query/Retrieve-SCP: Association Rejection Reasons 52

Table 2-39: Query/Retrieve-SCP: Accepted Presentation Contexts 53

Table 2-40: Query/Retrieve-SCP: Study Root/Study Level Matching Keys 54

Table 2-41: Query-Retrieve-SCP: C-FIND Response Status Return Behavior 55

Table 2-42: Query-Retrieve-SCP: C-MOVE Response Status Return Behavior 56

Table 2-43: Query-Retrieve-SCP: Communication Failure Behavior 56

Table 2-44: Query/Retrieve-SCU: Supported SOP Classes 57

Table 2-45: Query/Retrieve-SCU: DICOM Application Context 57

Table 2-46: Query/Retrieve-SCU: Number of Associations Accepted 57

Table 2-47: Query/Retrieve-SCU: Asynchronous Nature 57

Table 2-48: Query/Retrieve-SCU: DICOM Implementation Class and Version 58

Table 2-49: Query/Retrieve-SCU: Proposed Presentation Contexts for FIND Request 59

Table 2-50: Query/Retrieve-SCU: Study Root Information Model Match Keys Allowed for User Entry 59

Table 2-51: Query/Retrieve-SCU: C-FIND Response Status.....	60
Table 2-52: Query/Retrieve-SCU: Proposed Presentation Contexts	61
Table 2-53: Query/Retrieve-SCU: Study Level Keys for the Study Root Query/retrieve Information Model	62
Table 2-54: Query/Retrieve-SCU: C-MOVE Response Status.....	62
Table 2-55: Verification AE: Supported SOP Classes	63
Table 2-56: Verification AE: DICOM Application Context.....	63
Table 2-57: Verification AE: Number of Associations Accepted.....	63
Table 2-58: Verification AE: Asynchronous Nature.....	63
Table 2-59: Verification AE: DICOM Implementation Class and Version.....	64
Table 2-60: Verification AE: Proposed Presentation Contexts	64
Table 2-61: Verification AE: C-ECHO Response Status.....	64
Table 2-62: Verification AE: Accepted Presentation Contexts	65
Table 2-63: PACS Text Interface: Supported SOP Classes.....	65
Table 2-64: PACS Text Interface: Acceptable Presentation Contexts	67
Table 2-65: PACS Text Interface: DIMSE-N Service Group for Patient IOD	68
Table 2-66: PACS Text Interface: Patient Notification Event Information	68
Table 2-67: PACS Text Interface: DIMSE-N Service Group for Visit IOD.....	69
Table 2-68: PACS Text Interface: Visit ADT Notification Event Information	69
Table 2-69: PACS Text Interface: DIMSE-N Service Group for Study IOD	71
Table 2-70: PACS Text Interface: Typical Imaging Types	72
Table 2-71: PACS Text Interface: Study Notification Event Information	73
Table 2-72: PACS Text Interface: DIMSE-N Service Group for Visit IOD.....	77
Table 2-73: PACS Text Interface: Interpretation Update Notification Event Information	77
Table 2-74: PACS Text Interface: DIMSE-N Service Group for Visit IOD.....	79
Table 2-75: PACS Text Interface: Examination Complete N-CREATE Attributes.....	79
Table 2-76: PACS Text Interface: Physician Sequences.....	82
Table 2-77: PACS Text Interface: Message Handle	85
Table 2-78: Supported System Management Profiles	85
Table 2-79: Supported DHCP Parameters	86
Table 2-80: Configuration Master Files	87
Table 2-81: AE Title Configuration	87
Table 2-82: Configuration Parameters	88
Table 3-1: VistA-Imaging-FSR Application Profiles, Activities, and Roles	91
Table 3-2: VistA Imaging FSR: IODs, SOP classes and Transfer Syntaxes.....	92

FIGURES

Figure 2-1: Functional Overview	9
Figure 2-2: Admission/Discharge/Transfer Sequence	14
Figure 2-3: Patient Registration Sequence.....	15
Figure 2-4: Exam Verification Sequence.....	16
Figure 2-5: Report Verification Sequence	16
Figure 2-6: Storage-SCP: Sequencing of Activity	21
Figure 2-7: Storage-SCU: Sequencing of Activity.....	29
Figure 2-8: Modality-Worklist-SCP: Sequencing of Activity.....	36
Figure 2-9: Modality-Worklist-SCU: Sequencing of Activity.....	44
Figure 2-10: Query/Retrieve-SCP: Sequencing of Activity.....	51
Figure 2-11: Query-Retrieve-SCU: User-initiated FIND Sequencing of Activity	58
Figure 2-12: Query-Retrieve-SCU: Examination Complete Sequencing of Activity.....	61
Figure 3-1: Application Data Flow Diagram for Media Storage	90
Figure 3-2: VistA-Imaging-FSR: Sequencing of Activity.....	92

CONTENTS

1 INTRODUCTION

This document is the combined conformance statement of the various DICOM components of VistA Imaging. It describes the Application Entities in the VistA DICOM interfaces supplying connectivity to the DICOM domain. The document complements the content provided in the *Joint VA/DoD DICOM Conformance Requirements for Digital Acquisition Modalities* document, available on the VistA Imaging DICOM page at www.va.gov/imaging/DICOM.asp.

VistA Imaging is a controlled image management and storage system. No system is permitted to interface with VistA Imaging except through a defined interface that has been validated by the VistA Imaging process. The VistA Imaging Program maintains a list of validated third-party devices that interface to VistA Imaging on the VistA Imaging DICOM page at www.va.gov/imaging/DICOM.asp. Contact the VistA Imaging team for more information.

1.1 Revision History

Revision	Date	Note	Author
6	Jun 24 2011	For MAG*3.0*49, update for new MWL elements ; minor clarifications to case ID info for PACS Text AE. For MAG*3.0*99, update for new transfer syntaxes for Storage and Query/Retrieve. Update references to PS 2007 to PS 2009. Minor corrections related to supported SOP classes. Future-dated to August to reflect anticipated release of MAG*3.0*94 and MAG*3.0*99.	Arianna McFarren
5	Dec 08 2010	Re-add Q/R SCP information for MAG*3.0*66.	Arianna McFarren
4	Sep 07 2010	Additions for new VistA-Imaging-FSR (Overview and Chapter 3). Update section 1.3 (Remarks) to reflect current policy. Updates for multithreaded Storage SCP and AE configuration.	Arianna McFarren Dee Csipo Roy Seabolt Bill Peterson
3.2	Nov 17 2009	Removed QR SCP information awaiting decision from VA authorities. Clarify content in Sequencing sections. Update Storage SCP and SCU sections for new SOP class support in MAG*3.0*54. Check content vs. all 2008 corrections and supplements to standard.	Arianna McFarren
3.1.1	Nov 17 2008	Corrected port number for QR SCP, removed incorrect statement about retrievals from QR SCU section.	Csaba Titton, Bill Peterson Arianna McFarren
3.1	Jan 15 2008	Updates for patches 5, 10, 52, and 66. Added new Storage SOP classes, and new DICOM services, specifically DICOM Q/R. General clarifications to descriptions of AEs. Restructured to reflect PS3.2-2007. WPR completed Feb 28 2008.	Dee Csipo, Bill Peterson Dan Carozza, Arianna McFarren
3.0.3	May 23 2003	Reflects Version 3 only, all V 2.5 references removed; references to DICOM Standard updated. Acronym list updated.	Dan Carozza
3.0.2	Jan 2 2002	Updated Section 2 – Introduction	Dan Carozza

INTRODUCTION

3.0.1	Dec 4 2002	Header changed – no content change	Dan Carozza
3.0.0	May 28 2002	Updates for Version 3.0. Special thanks to Herman Oosterwijk, OTech Imaging, Inc.	Dee Csipo
2.5.2	Mar 16 2000	Final edit and formatting	Dee Csipo
2.5.1	Mar 15 2000	Comments from Peter Kuzmak	Dee Csipo
2.5.0	Mar 9 2000	Initial Re-write for VistA Imaging V2.5	Dee Csipo

1.2 Audience

This document is written to address the needs of anyone wanting to interface to the VistA Imaging DICOM domain. This includes both those responsible for overall imaging network policy and architecture, as well as integrators who need to have a detailed understanding of the DICOM features of the product. This document contains some basic DICOM definitions so that any reader may understand how this product implements DICOM features. However, integrators are expected to fully understand all the DICOM terminology, how the tables in this document relate to the product's functionality, and how that functionality integrates with other devices that support compatible DICOM features.

1.3 Remarks

This document is organized in accordance with the templates provided by PS3.2-2009. The document is not a substitute for other user and system documentation, but is an extension of the information supplied in the full documentation and presented in a format suitable for evaluating potential interoperability.

VistA Imaging has been tested to assure adherence to this Conformance Statement. Note that adherence to this Conformance Statement and the DICOM standard does not guarantee that other vendors' products will be fully interoperable with VistA Imaging. In accordance with the FDA's Quality System Regulation and VA policy, vendor's products must undergo validation testing as documented in the test procedures posted at www.va.gov/imaging/DICOM.asp before being integrated with VistA Imaging's DICOM components.

This document may include technical inaccuracies and/or typographical errors. Changes are periodically made to the information herein and incorporated into new revisions of this document.

This document is maintained by the VistA Imaging Project.

1.4 Terms and Definitions

The following terms are used in this Conformance Statement. These Informal definitions are provided for convenience; DICOM Standard is the authoritative source for formal definitions of these terms.

Abstract Syntax – the information agreed to be exchanged between applications, generally equivalent to a Service/Object Pair (SOP) Class. Examples: Verification SOP Class, Modality Worklist Information Model Find SOP Class, Computed Radiography Image Storage SOP Class.

Application Entity (AE) – an end point of a DICOM information exchange, including the DICOM network or media interface software; i.e., the software that sends or receives DICOM information objects or messages. A single device may have multiple Application Entities.

Application Entity Title – the externally known name of an *Application Entity*, used to identify a DICOM application to other DICOM applications on the network.

Application Context – the specification of the type of communication used between *Application Entities*. Example: DICOM network protocol.

Association – a network communication channel set up between *Application Entities*.

Attribute – a unit of information in an object definition; a data element identified by a *tag*. The information may be a complex data structure (Sequence), itself composed of lower level data elements. Examples: Patient ID (0010,0020), Accession Number (0008,0050), Photometric Interpretation (0028,0004), Procedure Code Sequence (0008,1032).

Clinical Specialties – In the context of this document, “clinical specialties” refers to non-radiological domains such as cardiology, eye care, dentistry, endoscopy, dermatology, surgery, etc.

Information Object Definition (IOD) – the specified set of *Attributes* that comprise a type of data object; does not represent a specific instance of the data object, but rather a class of similar data objects that have the same properties. The *Attributes* may be specified as Mandatory (Type 1), Required but possibly unknown (Type 2), or Optional (Type 3), and there may be conditions associated with the use of an Attribute (Types 1C and 2C). Examples: MR Image IOD, CT Image IOD.

Joint Photographic Experts Group (JPEG) – a set of standardized image compression techniques, available for use by DICOM applications.

Media Application Profile – the specification of DICOM information objects and encoding exchanged on removable media (e.g., CDs).

Module – a set of *Attributes* within an *Information Object Definition* that are logically related to each other. Example: Patient Module includes Patient Name, Patient ID, Patient Birth Date, and Patient Sex.

Presentation Context – the set of DICOM network services used over an *Association*, as negotiated between *Application Entities*; includes *Abstract Syntaxes* and *Transfer Syntaxes*.

Protocol Data Unit (PDU) – a packet (piece) of a DICOM message sent across the network. Devices must specify the maximum size packet they can receive for DICOM messages.

Security Profile – a set of mechanisms, such as encryption, user authentication, or digital signatures, used by an *Application Entity* to ensure confidentiality, integrity, and/or availability of exchanged DICOM data

Service Class Provider (SCP) – role of an *Application Entity* that provides a DICOM network service; typically, a server that performs operations requested by another *Application Entity (Service Class User)*. Examples: Picture Archiving and Communication System (image storage SCP, and image query/retrieve SCP), Radiology Information System (modality worklist SCP).

Service Class User (SCU) – role of an *Application Entity* that uses a DICOM network service; typically, a client. Examples: imaging modality (image storage SCU, and modality worklist SCU), imaging workstation (image query/retrieve SCU)

Service/Object Pair (SOP) Class – the specification of the network or media transfer (service) of a particular type of data (object); the fundamental unit of DICOM interoperability specification. Examples: Ultrasound Image Storage Service, Basic Grayscale Print Management.

Service/Object Pair (SOP) Instance – an information object; a specific occurrence of information exchanged in a *SOP Class*. Examples: a specific x-ray image.

Tag – a 32-bit identifier for a data element, represented as a pair of four digit hexadecimal numbers, the “group” and the “element”. If the “group” number is odd, the tag is for a private (manufacturer-specific) data element. Examples: (0010,0020) [Patient ID], (07FE,0010) [Pixel Data], (0019,0210) [private data element]

Transfer Syntax – the encoding used for exchange of DICOM information objects and messages. Examples: *JPEG* compressed (images), little endian explicit value representation.

Unique Identifier (UID) – a globally unique “dotted decimal” string that identifies a specific object or a class of objects; an ISO-8824 Object Identifier. Examples: Study Instance UID, SOP Class UID, SOP Instance UID.

Value Representation (VR) – the format type of an individual DICOM data element, such as text, an integer, a person’s name, or a code. DICOM information objects can be transmitted with either explicit identification of the type of each data element (Explicit VR), or without explicit identification (Implicit VR); with Implicit VR, the receiving application must use a DICOM data dictionary to look up the format of each data element.

1.5 Basics of DICOM Communication

This section describes terminology used in this Conformance Statement for the non-specialist. The key terms used in the Conformance Statement are highlighted in italics below. This section is not a substitute for training about DICOM, and it makes many simplifications about the meanings of DICOM terms.

Two *Application Entities* (devices) that want to communicate with each other over a network using DICOM protocol must first agree on several things during an initial network “handshake”. One of the two devices must initiate an *Association* (a connection to the other device), and ask if specific services, information, and encoding can be supported by the other device (*Negotiation*).

DICOM specifies a number of network services and types of information objects, each of which is called an *Abstract Syntax* for the Negotiation. DICOM also specifies a variety of methods for encoding data, denoted *Transfer Syntaxes*. The Negotiation allows the initiating Application Entity to propose combinations of Abstract Syntax and Transfer Syntax to be used on the Association; these combinations are called *Presentation Contexts*. The receiving Application Entity accepts the Presentation Contexts it supports.

For each Presentation Context, the Association Negotiation also allows the devices to agree on *Roles* – which one is the *Service Class User* (SCU - client) and which is the *Service Class Provider* (SCP - server). Normally the device initiating the connection is the SCU, i.e., the client system calls the server, but not always.

The Association Negotiation finally enables exchange of maximum network packet (*PDU*) size, security information, and network service options (called *Extended Negotiation* information).

The Application Entities, having negotiated the Association parameters, may now commence exchanging data. Common data exchanges include queries for worklists and lists of stored images, transfer of image objects and analyses (structured reports), and sending images to film printers. Each exchangeable unit of data is formatted by the sender in accordance with the appropriate *Information Object Definition*, and sent using the negotiated Transfer Syntax. There is a Default Transfer Syntax that all systems must accept, but it may not be the most efficient for some use cases. Each transfer is explicitly acknowledged by the receiver with a *Response Status* indicating success, failure, or that query or retrieve operations are still in process.

1.6 Abbreviations

AE	Application Entity
CR	Computed Radiography
CT	Computed Tomography
DHCP	Dynamic Host Configuration Protocol
DICOM	Digital Imaging and Communications in Medicine
DIMSE	DICOM Message Service Element

INTRODUCTION

DIMSE-C	DICOM Message Service Element Composite
DIMSE-N	DICOM Message Service Element Normalized
DNS	Domain Name System
DX	Digital Radiography
FSC	File-set Creator
FSR	File-set Reader
FSU	File-set Updater
HIS	Hospital Information System
HL7	Health Level 7
ID	Identifier
IHE	Integrating the Healthcare Enterprise
IOD	Information Object Definition
IPv4	Internet Protocol version 4
IPv6	Internet Protocol version 6
ISO	International Standards Organization
JPEG	Joint Photographic Experts Group
LDAP	Lightweight Directory Access Protocol
LUT	Look-up Table
MA	Magnetic Resonance Angiography
MR	Magnetic Resonance
MTU	Maximum Transmission Unit
MWL	Modality Worklist
NM	Nuclear Medicine
NTP	Network Time Protocol
PACS	Picture Archiving and Communication System
PET	Positron Emission Tomography
PDU	Protocol Data Unit
RF	Radio Fluoroscopy
RIS	Radiology Information System
SC	Secondary Capture
SCP	Service Class Provider
SCU	Service Class User
SOP	Service-Object Pair
TCP/IP	Transmission Control Protocol/Internet Protocol
UID	Unique Identifier
UL	Upper Layer
US	Ultrasound
VA	Department of Veterans Affairs

VistA	VA Hospital Information System Technology Architecture
VL	Visible Light
VR	Value Representation
XA	X-Ray Angiography

1.7 References

The following documents are available on the VistA Imaging DICOM page at www.va.gov/imaging/DICOM.asp.

Joint VA / DoD DICOM Conformance Requirements for Digital Acquisition Modalities

DICOM Modality Validation Test Procedure

VistA Imaging Approved DICOM Modality Interfaces

Profiles for the VistA Imaging and Commercial PACS DICOM Interface

The following documents are available on the VistA Imaging HL7 page at <http://www.va.gov/imaging/HL7.asp>.

Profiles for HL7 Messages from VistA to Commercial PACS

Summary of PACS HL7 Testing for Scheduled Workflow

VistA Imaging Approved PACS HL7 Interfaces

NEMA PS3 Digital Imaging and Communications in Medicine (DICOM) Standard, available at <http://medical.nema.org/>.

IHE Radiology Technical Framework, revision 8.0, available at www.ihe.net/Technical_Framework/index.cfm.

INTRODUCTION

2 NETWORKING

2.1 Implementation Model

2.1.1 Application Data Flow

The figure below illustrates the data flow between VistA Imaging AEs and remote AEs.

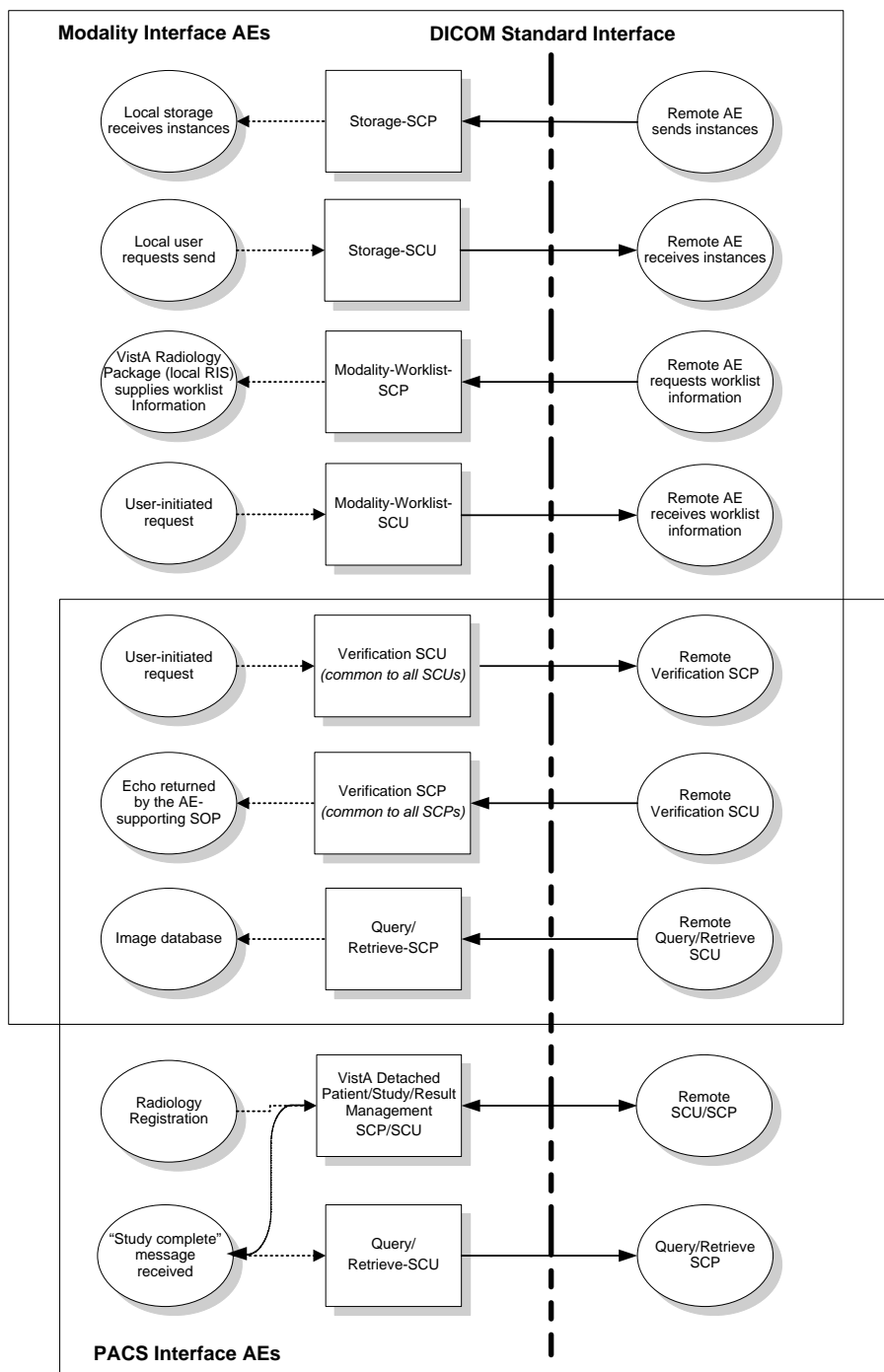

Figure 2-1: Functional Overview

The AEs that implement VistA Imaging are independent of each other and are loosely coupled through messaging interfaces. Events on one interface may, or may not, trigger activity on another interface. The following sequence of DICOM events is handled by each AE.

Storage-SCP

- The receipt of an association
- The receipt of a DICOM C-STORE message(s)
- The return of a C-STORE Response(s)
- The receipt of association close request

Storage-SCU

- The establishment of the association
- The sending of the DICOM C-STORE message(s)
- The receipt of the C-STORE response(s)
- The closing of the association

Modality-Worklist-SCP

- The receipt of an association request
- The receipt of a DICOM C-FIND request
- The generation of the DICOM C-FIND response(s)
- The receipt of a close association request

Modality-Worklist-SCU

- The establishment of the association
- The sending of the DICOM C-FIND request
- The receipt of the C-FIND response(s)
- The sending of the close association

Query/Retrieve-SCP

- Study Root Query SCP
 - The acceptance of the DICOM association
 - The receipt of the DICOM C-FIND request
 - The generation and sending of the C-FIND response(s)
 - The receipt and acknowledgement of the association release request
- Study Root Move SCP
 - The acceptance of the DICOM association
 - The receipt of the C-MOVE request
 - The sending of the C-MOVE response(s)
 - The receipt and acknowledgement of the association release request

Query/Retrieve-SCU

- Study Root Query SCU
 - The establishment of the association
 - The sending of the query
 - The processing of results
 - The release of the association
- Study Root Move SCU
 - The establishment of the association
 - The sending of the C-MOVE request
 - The receipt of the C-MOVE response(s)
 - The closing of the association

Verification SCU/SCP

- SCU
 - The establishment of the association
 - The sending of the C-ECHO request
 - The receipt of the C-ECHO response
 - The release of the association
- SCP
 - The acceptance of the association
 - The receipt of the C-ECHO request
 - The sending of the C-ECHO response
 - The acknowledgement of the association release request

VA Detached patient/study/result management SCP (Retired)

- The acceptance of the association
- The issue of N-EVENT_REPORTS
- The processing of responses
- The acknowledgement of the association release request

2.1.2 Functional Definitions of Local Application Entities

This section describes the function of each local Application Entity.

2.1.2.1 Storage-SCP

Storage-SCP receives, stores, and archives DICOM SOP Instances (typically images) received from remote storage SCUs. Storage-SCP provides multiple listening threads that accept and service connections for a port. Multiple instances of Storage-SCP can be run to service additional ports.

2.1.2.2 Storage-SCU

Storage-SCU transmits DICOM SOP Instances (typically images) from VistA Imaging to remote Storage SCPs, and accepts the acknowledgement of receipt of the images by the remote SCP. The SCU will offer contexts required for the SOP Instances stored in the VistA Imaging database.

2.1.2.3 Modality-Worklist-SCP

Modality-Worklist-SCP provides modality worklist for traditional radiology modalities as well as modalities in other clinical specialties, like dentistry, ophthalmology, pathology, endoscopy, etc.

2.1.2.4 Modality-Worklist-SCU

Modality-Worklist-SCU is a user-driven utility developed for testing system configuration. It provides a convenient tool to query the Modality-Worklist-SCP during initial installation. Modality-Worklist-SCU is only used for troubleshooting.

2.1.2.5 Query/Retrieve-SCP

Query/Retrieve-SCP provides access to images stored in VistA Imaging. Users of this service have to conform to both the physical and logical security constraints established by the local facility to gain access to image information. Query/Retrieve-SCP implements Study Root C-FIND, Study Root C-MOVE, and the Storage-SCU described elsewhere in this document.

The DICOM C-MOVE service supplies the Unique Key values to identify an entity at the level of retrieval. The SCP of the C-MOVE initiates C-STORE sub-operations for the corresponding storage SOP instances identified by the Unique Key values. The SCP of the Query/Retrieve Service Class serves as an SCU of the Storage Service Class.

2.1.2.5 Query/Retrieve-SCU

Query/Retrieve-SCU is part of the workflow management system implemented by VistA Imaging. It is driven from the VA Detached Study management services.

Query/Retrieve-SCU can be used to manually verify the existence and content of studies on a connected PACS. The content information is then used to retrieve images from the commercial PACS to VistA Imaging.

On receipt of an Examination Complete notification from a commercial PACS system, Query/Retrieve-SCU automatically requests that the PACS move image instances to VistA Imaging.

2.1.2.6 Verification SCU/SCP

The Verification SCU is a user-driven utility used to verify the configuration of remote SCPs. Verification-SCP support is required by any local AE accepting an association.

2.1.2.7 VistA VA Detached Patient/Study/Result management SCP (retired)

This SCP provides notification interfaces for PACS systems connected to VistA Imaging. The interface implements support for a number of private SOP classes modeled after the DICOM Detached Patient/Study management services. A single SCP services all connected SCUs.

Table 2-1: PACS Interface Messages

Real World Event	Direction	Detached VA SOP Class & Event Type
Patient Demographic Change	VistA→PACS	Patient Management, Patient Updated
ADT	VistA→PACS	Visit Management, Visit Updated
Order Entry	VistA→PACS	Study Management, Study Created
Examination Change (cancel)	VistA→PACS	Study Management, Study Updated
Examination Verification	VistA→PACS	Study Management, Study Updated
Examination Complete	VistA←PACS	N-CREATE of the Study Component Management
Make Image Request	VistA→PACS	C-MOVE request of Query/Retrieve
Get Image Data	VistA←PACS	C-STORE of Storage Service
Get Image Response	VistA←PACS	C-MOVE response of Query/Retrieve
Report Transfer	VistA→PACS	Interpretation Management, Interpretation Updated

2.1.3 Sequencing of Real World Activities

VistA Imaging DICOM components provide DICOM connectivity for the VistA Hospital Information System (HIS). The activities are coordinated by the events generated by the HIS, which are related to patient movement throughout the hospital.

The following sequences of events are tracked during a normal encounter. Separate sequences are presented for Radiology and for Clinical Specialties.

2.1.3.1 Real World Events and Message Sequence Relationship--Radiology

The sequence described in the following subsections does not imply any time scale, just the temporal order of events. (i.e., event A must occur before event B and so on).

In each transition from one state of the process to the next, the underlying information systems exchange the necessary messages. Each activity results in the generation of specific HL7 or DICOM messages.

2.1.3.1.1 Patient Registration/Patient Demographic Change and Admission/Discharge/Transfer

When the patient is registered, the patient related information is entered into the database. A patient demographics PACS interface message is generated as a result of this event. The system may issue a change to the patient’s demographic information. This event is transmitted to the remote entities as a PACS interface message.

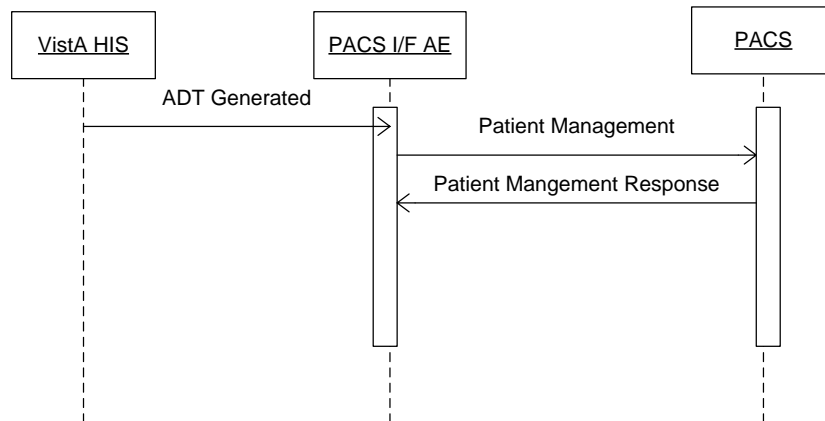

Figure 2-2: Admission/Discharge/Transfer Sequence

2.1.3.1.2 Order Entry

The Ordering system generates a new order for the patient. The transaction generates internal messages and prepares the patient for the arrival at Radiology. None of the modality specific DICOM interfaces are affected.

2.1.3.1.3 Order Update

The system may issue a change to the original order any time before image acquisition. The primary use of order updates is to indicate cancellations to connected systems using a

PACS interface message. An order might also be updated if the technician adds more data such as CPT modifier or Technologist Name after the original order entry.

2.1.3.1.4 Patient Registration (Radiology)

When the patient arrival event occurs (which is not necessarily tied to the physical arrival of the actual patient) the requested procedures are decomposed into the respective Scheduled Procedure Steps and the information is made available on the Modality Worklist. The Modality Worklist contains information with Scheduled Procedure Step granularity. The ordering information is also conveyed to the remote systems in a PACS interface message.

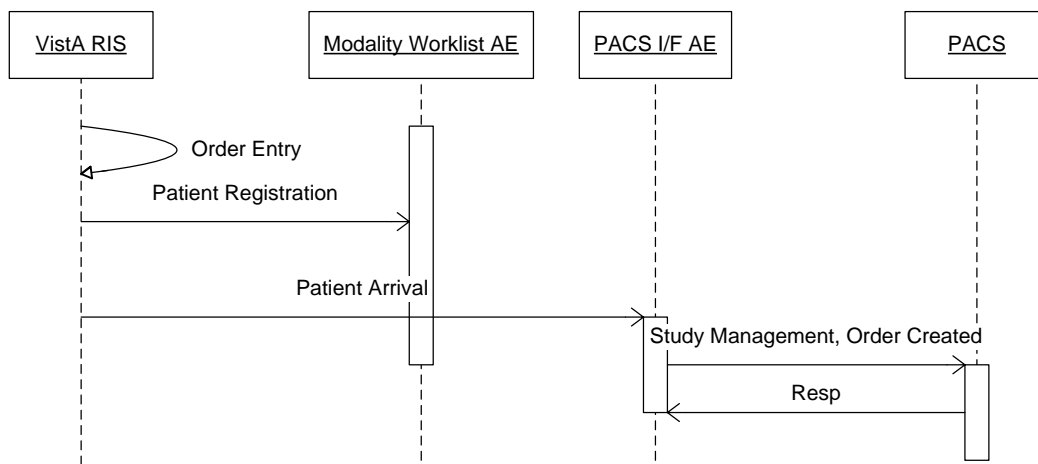

Figure 2-3: Patient Registration Sequence

2.1.3.1.5 Exam Verification

After the images have been associated with the proper patient and study and permanently stored, the performing technologist reviews the images. When the images are verified to be of diagnostic quality, the study is removed from the modality worklist and placed on the Radiologist Unread List. The system generates a study notification event with a “Verified” event ID.

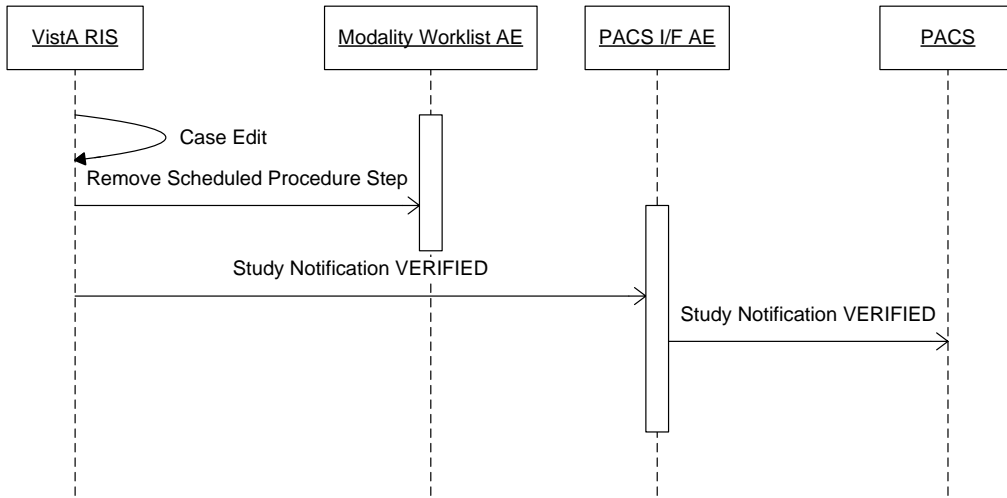

Figure 2-4: Exam Verification Sequence

2.1.3.1.6 Report Dictated/Transcribed

A radiologist interprets the image and enters a report. The system transmits the transcribed report whenever it becomes available to all connected SCUs in the form of a PACS interface message.

2.1.3.1.7 Report Verified

After the radiologist verifies (signs) the report, the system transmits the report whenever it becomes available to all connected SCUs in the form of a PACS interface message.

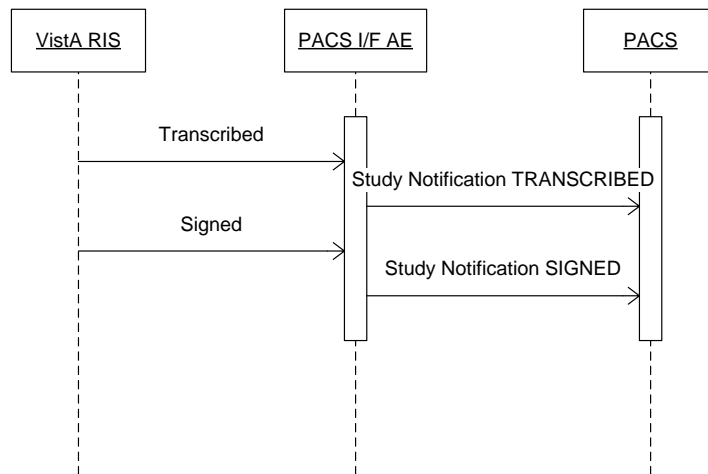

Figure 2-5: Report Verification Sequence

2.1.3.2 Real World Events and Message Sequence Relationship—Clinical Specialties

VistA supports a DICOM acquisition interface for the Clinical Specialties (such as cardiology, eye care, dentistry, endoscopy, dermatology, surgery). The workflow in clinical specialties is primarily handled by the Computerized Patient Record System (CPRS) Consult Request Tracking package.

2.1.3.2.1 CPRS Order Entry

A primary care provider uses CPRS to place an order to a clinical specialty service for either a consult or a procedure request. If the clinical specialty service is DICOM-enabled, the request is immediately placed into the DICOM Modality Worklist database. Patient and study identification information is stored in the database at this time. The appointment is not made at this time and scheduling information is not present in the database.

2.1.3.2.2 CPRS Pre-visit Actions

There are several actions that can be performed using CPRS for the request. For example it can be “accepted”, a comment can be added to the request, it can be “forwarded” to another clinical specialty service, or it can be canceled. All of these actions trigger updates to the DICOM Modality Worklist database.

2.1.3.2.3 Clinical Specialty Appointment Scheduling

The VA Appointment Management package may or may not be used to schedule an appointment for the consult/procedure request. If it is used, then scheduling information is added to DICOM Modality Worklist database.

2.1.3.2.4 Clinical Specialty Patient Arrival

When the patient arrives at the modality, the technologist performs a Modality Worklist query to down-load patient and study information. The VA allows the use of “Short ID” (initial of the patient’s last name + last four digits of the patient’s social security number) be used as the query key in either the Patient Name (0010,0010) or Patient ID (0010,0020) attribute.

2.1.3.2.5 Clinical Specialty Image Acquisition

DICOM acquisition will proceed normally after the Modality Worklist query has been performed, using the values from it to update the header. Images are sent to VistA, where they are automatically associated with the corresponding patient and consult or procedure request.

2.1.3.2.6 Clinical Specialty Completion

A provider will review the images on VistA and enter a textual result for the consult or procedure request using CPRS. When this is done, the request is completed and is removed from the DICOM Modality Worklist.

2.1.3.2.7 Clinical Specialty Follow-up Visits

Images for some follow-up visits need to be stored with the original consult or procedure request. For example, a patient has intra-ocular lens replacement surgery. Images may be taken three time, first for the surgery for left eye, then a week later, to record healing of the left eye and for the surgery for the right eye, and then a week later to record the healing of the right eye. CPRS provides a mechanism to reopen a consult/procedure request (by entering an unsigned note) which places the study back onto the DICOM Modality Worklist making it easy to retrieve using the “Short ID” query method described above. Signing the note removes it from the worklist again. Alternatively, an Accession Number query can be used to bypass the DICOM Modality Worklist database and retrieve the study directly from VistA.

2.2 AE Specifications

2.2.1 Storage-SCP AE Specification

2.2.1.1 SOP Classes

The Storage-SCP application entity provides Standard Conformance to the following SOP Classes:

Table 2-2: Storage-SCP: Supported SOP Classes

SOP Class Name	SOP Class UID	SCU	SCP
Verification	1.2.840.10008.1.1	No	Yes
Computed Radiography Image Storage	1.2.840.10008.5.1.4.1.1.1	No	Yes
Digital X-Ray Image Storage - For Presentation	1.2.840.10008.5.1.4.1.1.1.1	No	Yes
Digital X-Ray Image Storage - For Processing	1.2.840.10008.5.1.4.1.1.1.1.1	No	Yes
Digital Mammography X-Ray Image Storage - For Presentation	1.2.840.10008.5.1.4.1.1.1.2	No	Yes
Digital Mammography X-Ray Image Storage - For Processing	1.2.840.10008.5.1.4.1.1.1.2.1	No	Yes
Digital Intra-oral X-Ray Image Storage – For Presentation	1.2.840.10008.5.1.4.1.1.1.3	No	Yes
Digital Intra-oral X-Ray Image Storage – For Processing	1.2.840.10008.5.1.4.1.1.1.3.1	No	Yes
CT Image Storage	1.2.840.10008.5.1.4.1.1.2	No	Yes

SOP Class Name	SOP Class UID	SCU	SCP
Ultrasound Multi-frame Image Storage (Retired)	1.2.840.10008.5.1.4.1.1.3	No	Yes
Ultrasound Multi-frame Image Storage	1.2.840.10008.5.1.4.1.1.3.1	No	Yes
MR Image Storage	1.2.840.10008.5.1.4.1.1.4	No	Yes
Nuclear Medicine Image Storage (Retired)	1.2.840.10008.5.1.4.1.1.5	No	Yes
Ultrasound Image Storage (Retired)	1.2.840.10008.5.1.4.1.1.6	No	Yes
Ultrasound Image Storage	1.2.840.10008.5.1.4.1.1.6.1	No	Yes
Secondary Capture Image Storage	1.2.840.10008.5.1.4.1.1.7	No	Yes
Multi-frame Grayscale Byte Secondary Capture Image Storage	1.2.840.10008.5.1.4.1.1.7.2	No	Yes
Multi-frame Grayscale Word Secondary Capture Image Storage	1.2.840.10008.5.1.4.1.1.7.3	No	Yes
Multi-frame True Color Secondary Capture Image Storage	1.2.840.10008.5.1.4.1.1.7.4	No	Yes
X-Ray Angiographic Image Storage	1.2.840.10008.5.1.4.1.1.12.1	No	Yes
X-Ray Radiofluoroscopic Image Storage	1.2.840.10008.5.1.4.1.1.12.2	No	Yes
Nuclear Medicine Image Storage	1.2.840.10008.5.1.4.1.1.20	No	Yes
VL Image Storage (Retired)	1.2.840.10008.5.1.4.1.1.77.1	No	Yes
VL Endoscopic Image Storage	1.2.840.10008.5.1.4.1.1.77.1.1	No	Yes
VL Slide-Coordinates Microscopic Image Storage	1.2.840.10008.5.1.4.1.1.77.1.3	No	Yes
VL Photographic Image Storage	1.2.840.10008.5.1.4.1.1.77.1.4	No	Yes
VL Microscopic Image Storage	1.2.840.10008.5.1.4.1.1.77.1.2	No	Yes
VL Multi-frame Image Storage (Retired)	1.2.840.10008.5.1.4.1.1.77.2	No	Yes
Ophthalmic Photography 16 Bit Image Storage	1.2.840.10008.5.1.4.1.1.77.1.5.2	No	Yes
Ophthalmic Photography 8 Bit Image Storage	1.2.840.10008.5.1.4.1.1.77.1.5.1	No	Yes
Encapsulated PDF Storage SOP Class	1.2.840.10008.5.1.4.1.1.104.1	No	Yes
Positron Emission Tomography Image Storage	1.2.840.10008.5.1.4.1.1.128	No	Yes
RT Image Storage	1.2.840.10008.5.1.4.1.1.481.1	No	Yes

2.2.1.2 Association Policies

2.2.1.2.1 General

Storage-SCP accepts but never initiates connections. The maximum PDU size offered is 32768 bytes. SOP Class Extended Negotiation is not supported. The DICOM standard Application context shall be specified.

Table 2-3: Storage-SCP: DICOM Application Context

Application Context Name	1.2.840.10008.3.1.1.1
--------------------------	-----------------------

2.2.1.2.2 Number of Associations

Table 2-4: Storage-SCP: Number of Associations Accepted

Maximum number of simultaneous Associations	5
---	---

* Multiple, identical Storage-SCP AEs listen on designated TCP/IP ports. SCUs may connect to their assigned listening ports. Storage-SCP accepts up to five associations on each listening port.

2.2.1.2.3 Asynchronous Nature

Storage-SCP does not support asynchronous communication (multiple transactions over a single Association).

Table 2-5: Storage-SCP: Asynchronous Nature

Maximum number of outstanding asynchronous transactions	1
---	---

2.2.1.2.4 Implementation Identifying Information

The implementation information for Storage-SCP is:

Table 2-6: Storage-SCP: DICOM Implementation Class and Version

Implementation Class UID	1.2.840.113754.2.1.3.0
Implementation Version Name	VA DICOM V3.0

2.2.1.3 Association Initiation Policy

Storage-SCP does not initiate Associations.

2.2.1.4 Association Acceptance Policy

The Storage-SCP AE will only accept Associations with valid application and presentation contexts. Multiple storage requests may be handled during an Association. The called AE is validated against a stored list of AEs based on configuration.

The Association must persist for the duration of each request. There is no set upper time limit between requests. If the Association is closed before a request has been completed, the outcome of the request is indeterminate.

2.2.1.4.1 Activity – Receive Storage Request

2.2.1.4.1.1 Description and Sequencing of Activities

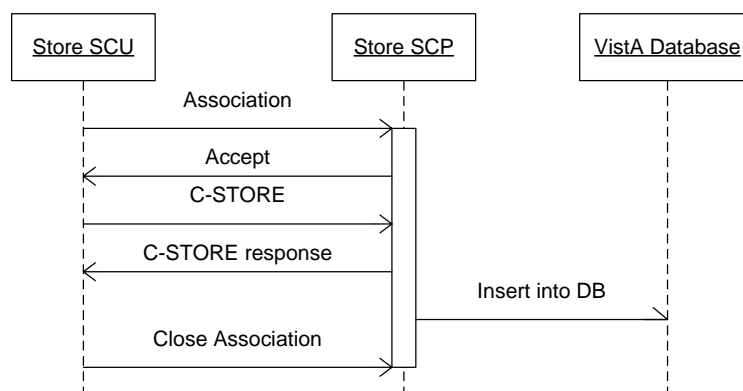

Figure 2-6: Storage-SCP: Sequencing of Activity

2.2.1.4.1.2 Accepted Presentation Contexts

Storage-SCP supports the Implicit VR Little Endian and Explicit VR Little Endian Transfer Syntaxes for all Associations. JPEG baseline (lossy) and JPEG lossless Transfer Syntaxes are also accepted for certain SOP classes (see table below).

In its default configuration, Storage-SCP will always select Explicit VR Little Endian if several supported Transfer Syntaxes are offered. To force Storage-SCP to accept the Implicit VR Little Endian Transfer Syntax, make it the only choice offered by a remote SCU.

Storage-SCP will always accept any Presentation Context for the supported SOP Classes with the supported Transfer Syntaxes. More than one proposed Presentation Context will be accepted for the same Abstract Syntax if the Transfer Syntax is supported, whether or not it is the same as another Presentation Context.

Table 2-7: Storage-SCP: Accepted Presentation Contexts

Presentation Context Table					
Abstract Syntax		Transfer Syntax		Role	Extended Negotiation
Name	UID	Name List	UID List		
Verification SOP Class	1.2.840.10008.1.1	Implicit VR Little Endian Explicit VR Little Endian Explicit VR Big Endian	1.2.840.10008.1.2 1.2.840.10008.1.2.1 1.2.840.10008.1.2.2	SCP	None
Computed Radiography Image Storage	1.2.840.10008.5.1.4.1.1.1	Implicit VR Little Endian Explicit VR Little Endian JPEG Lossy Baseline (Process 1) JPEG Lossless, Non-Hierarchical (Process 14)	1.2.840.10008.1.2 1.2.840.10008.1.2.1 1.2.840.10008.1.2.4.50 1.2.840.10008.1.2.4.57	SCP	None
Digital X-Ray Image Storage - For Presentation	1.2.840.10008.5.1.4.1.1.1.1	Implicit VR Little Endian Explicit VR Little Endian JPEG Lossy Baseline (Process 1) JPEG Lossless, Non-Hierarchical (Process 14)	1.2.840.10008.1.2 1.2.840.10008.1.2.1 1.2.840.10008.1.2.4.50 1.2.840.10008.1.2.4.5	SCP	None
Digital X-Ray Image Storage - For Processing	1.2.840.10008.5.1.4.1.1.1.1.1	Implicit VR Little Endian Explicit VR Little Endian	1.2.840.10008.1.2 1.2.840.10008.1.2.1	SCP	None
Digital Mammography X-Ray Image Storage - For Presentation	1.2.840.10008.5.1.4.1.1.1.2	Implicit VR Little Endian Explicit VR Little Endian	1.2.840.10008.1.2 1.2.840.10008.1.2.1	SCP	None
Digital Mammography X-Ray Image Storage - For Processing	1.2.840.10008.5.1.4.1.1.1.2.1	Implicit VR Little Endian Explicit VR Little Endian	1.2.840.10008.1.2 1.2.840.10008.1.2.1	SCP	None
Digital Intra-oral X-Ray Image Storage - For Presentation	1.2.840.10008.5.1.4.1.1.1.3	Implicit VR Little Endian Explicit VR Little Endian JPEG Lossy Baseline (Process 1) JPEG Lossless, Non-Hierarchical (Process 14)	1.2.840.10008.1.2 1.2.840.10008.1.2.1 1.2.840.10008.1.2.4.50 1.2.840.10008.1.2.4.57	SCP	None
Digital Intra-oral X-Ray Image Storage - For Processing	1.2.840.10008.5.1.4.1.1.1.3.1	Implicit VR Little Endian Explicit VR Little Endian	1.2.840.10008.1.2 1.2.840.10008.1.2.1	SCP	None
CT Image Storage	1.2.840.10008.5.1.4.1.1.2	Implicit VR Little Endian Explicit VR Little Endian JPEG Lossy Baseline (Process 1) JPEG Lossless, Non-Hierarchical (Process 14)	1.2.840.10008.1.2 1.2.840.10008.1.2.1 1.2.840.10008.1.2.4.50 1.2.840.10008.1.2.4.57	SCP	None
Ultrasound Multi-frame Image Storage (Retired)	1.2.840.10008.5.1.4.1.1.3	Implicit VR Little Endian Explicit VR Little Endian JPEG Lossy Baseline (Process 1) JPEG Lossless, Non-Hierarchical (Process 14)	1.2.840.10008.1.2 1.2.840.10008.1.2.1 1.2.840.10008.1.2.4.50 1.2.840.10008.1.2.4.57	SCP	None

Presentation Context Table					
Abstract Syntax		Transfer Syntax		Role	Extended Negotiation
Name	UID	Name List	UID List		
Ultrasound Multi-frame Image Storage	1.2.840.10008.5.1.4.1.1.3.1	Implicit VR Little Endian Explicit VR Little Endian JPEG Lossy Baseline (Process 1) JPEG Lossless Non-Hierarchical (Process 14)	1.2.840.10008.1.2 1.2.840.10008.1.2.1 1.2.840.10008.1.2.4.50 1.2.840.10008.1.2.4.57	SCP	None
MR Image Storage	1.2.840.10008.5.1.4.1.1.4	Implicit VR Little Endian Explicit VR Little Endian JPEG Lossy Baseline (Process 1) JPEG Lossless, Non-Hierarchical (Process 14)	1.2.840.10008.1.2 1.2.840.10008.1.2.1 1.2.840.10008.1.2.4.50 1.2.840.10008.1.2.4.57	SCP	None
Nuclear Medicine Image Storage (Retired)	1.2.840.10008.5.1.4.1.1.5	Implicit VR Little Endian Explicit VR Little Endian JPEG Lossy Baseline (Process 1) JPEG Lossless, Non-Hierarchical (Process 14)	1.2.840.10008.1.2 1.2.840.10008.1.2.1 1.2.840.10008.1.2.4.50 1.2.840.10008.1.2.4.57	SCP	None
Ultrasound Image Storage (Retired)	1.2.840.10008.5.1.4.1.1.6	Implicit VR Little Endian Explicit VR Little Endian JPEG Lossy Baseline (Process 1) JPEG Lossless, Non-Hierarchical (Process 14)	1.2.840.10008.1.2 1.2.840.10008.1.2.1 1.2.840.10008.1.2.4.50 1.2.840.10008.1.2.4.57	SCP	None
Ultrasound Image Storage	1.2.840.10008.5.1.4.1.1.6.1	Implicit VR Little Endian Explicit VR Little Endian JPEG Lossy Baseline (Process 1) JPEG Lossless Non-Hierarchical (Process 14)	1.2.840.10008.1.2 1.2.840.10008.1.2.1 1.2.840.10008.1.2.4.50 1.2.840.10008.1.2.4.57	SCP	None
Secondary Capture Image Storage	1.2.840.10008.5.1.4.1.1.7	Implicit VR Little Endian Explicit VR Little Endian JPEG Lossy Baseline (Process 1) JPEG Lossless Non-Hierarchical (Process 14)	1.2.840.10008.1.2 1.2.840.10008.1.2.1 1.2.840.10008.1.2.4.50 1.2.840.10008.1.2.4.57	SCP	None
Multi-frame Grayscale Byte Secondary Capture Image Storage	1.2.840.10008.5.1.4.1.1.7.2	Implicit VR Little Endian Explicit VR Little Endian JPEG Lossy Baseline (Process 1) JPEG Lossless Non-Hierarchical (Process 14)	1.2.840.10008.1.2 1.2.840.10008.1.2.1 1.2.840.10008.1.2.4.50 1.2.840.10008.1.2.4.57	SCP	None
Multi-frame Grayscale Word Secondary Capture Image Storage	1.2.840.10008.5.1.4.1.1.7.3	Implicit VR Little Endian Explicit VR Little Endian JPEG Lossy Baseline (Process 1) JPEG Lossless Non-Hierarchical (Process 14)	1.2.840.10008.1.2 1.2.840.10008.1.2.1 1.2.840.10008.1.2.4.50 1.2.840.10008.1.2.4.57	SCP	None

NETWORKING

Presentation Context Table					
Abstract Syntax		Transfer Syntax		Role	Extended Negotiation
Name	UID	Name List	UID List		
Multi-frame True Color Secondary Capture Image Storage	1.2.840.10008.5.1.4.1.1.7.4	Implicit VR Little Endian Explicit VR Little Endian JPEG Lossy Baseline (Process 1) JPEG Lossless Non-Hierarchical (Process 14)	1.2.840.10008.1.2 1.2.840.10008.1.2.1 1.2.840.10008.1.2.4.50 1.2.840.10008.1.2.4.57	SCP	None
X-Ray Angiographic Image Storage	1.2.840.10008.5.1.4.1.1.12.1	Implicit VR Little Endian Explicit VR Little Endian JPEG Lossy Baseline (Process 1) JPEG Lossless Non-Hierarchical (Process 14)	1.2.840.10008.1.2 1.2.840.10008.1.2.1 1.2.840.10008.1.2.4.50 1.2.840.10008.1.2.4.57	SCP	None
X-Ray Radiofluoroscopic Image Storage	1.2.840.10008.5.1.4.1.1.12.2	Implicit VR Little Endian Explicit VR Little Endian JPEG Lossy Baseline (Process 1) JPEG Lossless Non-Hierarchical (Process 14)	1.2.840.10008.1.2 1.2.840.10008.1.2.1 1.2.840.10008.1.2.4.50 1.2.840.10008.1.2.4.57	SCP	None
Nuclear Medicine Image Storage	1.2.840.10008.5.1.4.1.1.20	Implicit VR Little Endian Explicit VR Little Endian JPEG Lossy Baseline (Process 1) JPEG Lossless Non-Hierarchical (Process 14)	1.2.840.10008.1.2 1.2.840.10008.1.2.1 1.2.840.10008.1.2.4.50 1.2.840.10008.1.2.4.57	SCP	None
VL Image Storage (Retired)	1.2.840.10008.5.1.4.1.1.77.1	Implicit VR Little Endian Explicit VR Little Endian JPEG Lossy Baseline (Process 1) JPEG Lossless Non-Hierarchical (Process 14)	1.2.840.10008.1.2 1.2.840.10008.1.2.1 1.2.840.10008.1.2.4.50 1.2.840.10008.1.2.4.57	SCP	None
VL Endoscopic Image Storage SOP Class	1.2.840.10008.5.1.4.1.1.77.1.1	Implicit VR Little Endian Explicit VR Little Endian JPEG Lossy Baseline (Process 1) JPEG Lossless Non-Hierarchical (Process 14)	1.2.840.10008.1.2 1.2.840.10008.1.2.1 1.2.840.10008.1.2.4.50 1.2.840.10008.1.2.4.57	SCP	None
VL Microscopic Image Storage SOP Class	1.2.840.10008.5.1.4.1.1.77.1.2	Implicit VR Little Endian Explicit VR Little Endian JPEG Lossy Baseline (Process 1) JPEG Lossless Non-Hierarchical (Process 14)	1.2.840.10008.1.2 1.2.840.10008.1.2.1 1.2.840.10008.1.2.4.50 1.2.840.10008.1.2.4.57	SCP	None
VL Slide-Coordinates Microscopic Image Storage	1.2.840.10008.5.1.4.1.1.77.1.3	Implicit VR Little Endian Explicit VR Little Endian JPEG Lossy Baseline (Process 1) JPEG Lossless Non-Hierarchical (Process 14)	1.2.840.10008.1.2 1.2.840.10008.1.2.1 1.2.840.10008.1.2.4.50 1.2.840.10008.1.2.4.57	SCP	None

Presentation Context Table					
Abstract Syntax		Transfer Syntax		Role	Extended Negotiation
Name	UID	Name List	UID List		
VL Photographic Image Storage SOP Class	1.2.840.10008.5.1.4.1.1.77.1.4	Implicit VR Little Endian Explicit VR Little Endian JPEG Lossy Baseline (Process 1) JPEG Lossless Non-Hierarchical (Process 14)	1.2.840.10008.1.2 1.2.840.10008.1.2.1 1.2.840.10008.1.2.4.50 1.2.840.10008.1.2.4.57	SCP	None
Ophthalmic Photography 8 Bit Image Storage	1.2.840.10008.5.1.4.1.1.77.1.5.1	Implicit VR Little Endian Explicit VR Little Endian JPEG Lossy Baseline (Process 1) JPEG Lossless Non-Hierarchical (Process 14)	1.2.840.10008.1.2 1.2.840.10008.1.2.1 1.2.840.10008.1.2.4.50 1.2.840.10008.1.2.4.57	SCP	None
Ophthalmic Photography 16 Bit Image Storage	1.2.840.10008.5.1.4.1.1.77.1.5.2	Implicit VR Little Endian Explicit VR Little Endian JPEG Lossy Baseline (Process 1) JPEG Lossless Non-Hierarchical (Process 14)	1.2.840.10008.1.2 1.2.840.10008.1.2.1 1.2.840.10008.1.2.4.50 1.2.840.10008.1.2.4.57	SCP	None
VL Multi-frame Image Storage (Retired)	1.2.840.10008.5.1.4.1.1.77.2	Implicit VR Little Endian Explicit VR Little Endian JPEG Lossy Baseline (Process 1) JPEG Lossless, Non-Hierarchical (Process 14)	1.2.840.10008.1.2 1.2.840.10008.1.2.1 1.2.840.10008.1.2.4.50 1.2.840.10008.1.2.4.57	SCP	None
Encapsulated PDF Storage SOP Class	1.2.840.10008.5.1.4.1.1.104.1	Implicit VR Little Endian Explicit VR Little Endian	1.2.840.10008.1.2 1.2.840.10008.1.2.1	SCP	None
Positron Emission Tomography Image Storage	1.2.840.10008.5.1.4.1.1.128	Implicit VR Little Endian Explicit VR Little Endian JPEG Lossy Baseline (Process 1) JPEG Lossless, Non-Hierarchical (Process 14)	1.2.840.10008.1.2 1.2.840.10008.1.2.1 1.2.840.10008.1.2.4.50 1.2.840.10008.1.2.4.57	SCP	None
RT Image Storage	1.2.840.10008.5.1.4.1.1.481.1	Implicit VR Little Endian Explicit VR Little Endian JPEG Lossy Baseline (Process 1) JPEG Lossless, Non-Hierarchical (Process 14)	1.2.840.10008.1.2 1.2.840.10008.1.2.1 1.2.840.10008.1.2.4.50 1.2.840.10008.1.2.4.57	SCP	None

2.2.1.4.1.3 SOP Specific Conformance: Storage SOP Classes

The system offers no specialization for any of the SOP classes supported by Storage-SCP. No extended negotiation is supported.

The value of the C-STORE priority attribute is ignored.

Storage-SCP behaves as described below in response to a C-STORE command.

Table 2-8: Storage-SCP: C-STORE Response Status

Service Status	Further Meaning	Status Codes	Behavior
Refused	Out of Resources	A7xx	Out of disk space
Error	Data Set does not match SOP Class	A9xx	Never sent – data set is not checked prior to storage
	Cannot understand	Cxxx	Never sent
Warning	Coercion of Data Elements	B000	Never sent – no coercion is ever performed
	Data Set does not match SOP Class	B007	Never sent – data set is not checked prior to storage
	Elements Discarded	B006	Never sent – all elements are always stored
Success		0000	

2.2.2 Storage-SCU AE Specification

2.2.2.1 SOP Classes

The Storage-SCU Application Entity provides Standard Conformance to the following SOP Classes:

Table 2-9: Storage-SCU: Supported SOP Classes

SOP Class Name	SOP Class UID	SCU	SCP
Verification	1.2.840.10008.1.1	Yes	No
Computed Radiography Image Storage	1.2.840.10008.5.1.4.1.1.1	Yes	No
Digital X-Ray Image Storage - For Presentation	1.2.840.10008.5.1.4.1.1.1.1	Yes	No
Digital X-Ray Image Storage - For Processing	1.2.840.10008.5.1.4.1.1.1.1.1	Yes	No
Digital Mammography X-Ray Image Storage - For Presentation	1.2.840.10008.5.1.4.1.1.1.2	Yes	No
Digital Mammography X-Ray Image Storage - For Processing	1.2.840.10008.5.1.4.1.1.1.2.1	Yes	No
Digital Intra-oral X-Ray Image Storage – For Presentation	1.2.840.10008.5.1.4.1.1.1.3	Yes	No
Digital Intra-oral X-Ray Image Storage – For Processing	1.2.840.10008.5.1.4.1.1.1.3.1	Yes	No
CT Image Storage	1.2.840.10008.5.1.4.1.1.2	Yes	No
Ultrasound Multi-frame Image Storage (Retired)	1.2.840.10008.5.1.4.1.1.3	Yes	No

SOP Class Name	SOP Class UID	SCU	SCP
Ultrasound Multi-frame Image Storage	1.2.840.10008.5.1.4.1.1.3.1	Yes	No
MR Image Storage	1.2.840.10008.5.1.4.1.1.4	Yes	No
Nuclear Medicine Image Storage (Retired)	1.2.840.10008.5.1.4.1.1.5	Yes	No
Ultrasound Image Storage (Retired)	1.2.840.10008.5.1.4.1.1.6	Yes	No
Ultrasound Image Storage	1.2.840.10008.5.1.4.1.1.6.1	Yes	No
Secondary Capture Image Storage	1.2.840.10008.5.1.4.1.1.7	Yes	No
Multi-frame Grayscale Byte Secondary Capture Image Storage	1.2.840.10008.5.1.4.1.1.7.2	Yes	No
Multi-frame Grayscale Word Secondary Capture Image Storage	1.2.840.10008.5.1.4.1.1.7.3	Yes	No
Multi-frame True Color Secondary Capture Image Storage	1.2.840.10008.5.1.4.1.1.7.4	Yes	No
X-Ray Angiographic Image Storage	1.2.840.10008.5.1.4.1.1.12.1	Yes	No
X-Ray Radiofluoroscopic Image Storage	1.2.840.10008.5.1.4.1.1.12.2	Yes	No
Nuclear Medicine Image Storage	1.2.840.10008.5.1.4.1.1.20	Yes	No
VL Image Storage (Retired)	1.2.840.10008.5.1.4.1.1.77.1	Yes	No
VL Endoscopic Image Storage	1.2.840.10008.5.1.4.1.1.77.1.1	Yes	No
VL Slide-Coordinates Microscopic Image Storage	1.2.840.10008.5.1.4.1.1.77.1.3	Yes	No
VL Photographic Image Storage	1.2.840.10008.5.1.4.1.1.77.1.4	Yes	No
VL Microscopic Image Storage	1.2.840.10008.5.1.4.1.1.77.1.2	Yes	No
VL Multi-frame Image Storage (Retired)	1.2.840.10008.5.1.4.1.1.77.2	Yes	No
Ophthalmic Photography 16 Bit Image Storage	1.2.840.10008.5.1.4.1.1.77.1.5.2	Yes	No
Ophthalmic Photography 8 Bit Image Storage	1.2.840.10008.5.1.4.1.1.77.1.5.1	Yes	No
Encapsulated PDF Storage SOP Class	1.2.840.10008.5.1.4.1.1.104.1	Yes	No
Positron Emission Tomography Image Storage	1.2.840.10008.5.1.4.1.1.128	Yes	No
RT Image Storage	1.2.840.10008.5.1.4.1.1.481.1	Yes	No

2.2.2.2 Association Policies

2.2.2.2.1 General

Storage-SCU initiates but never accepts connections. The maximum PDU size offered by Storage-SCU is 32768 bytes. SOP Class Extended Negotiation is not supported. The DICOM standard Application context shall be specified.

Table 2-10: Storage-SCU: DICOM Application Context

Application Context Name	1.2.840.10008.3.1.1.1
--------------------------	-----------------------

2.2.2.2.2 Number of Associations

Table 2-11: Storage-SCU: Number of Associations Accepted

Maximum number of simultaneous Associations	1
---	---

2.2.2.2.3 Asynchronous Nature

Storage-SCU does not support asynchronous communication (multiple transactions over a single Association).

Table 2-12: Storage-SCU: Asynchronous Nature

Maximum number of outstanding asynchronous transactions	1
---	---

2.2.2.2.4 Implementation Identifying Information

The implementation information for Storage-SCU is:

Table 2-13: Storage-SCU: DICOM Implementation Class and Version

Implementation Class UID	1.2.840.113754.2.1.3.0
Implementation Version Name	VA DICOM V3.0

2.2.2.3 Association Initiation Policy

The association is initiated as a result of a manual or automatic request to transmit an image or a set of images.

2.2.2.3.1 Activity – Transmit Images

Storage-SCU initiates an association of the proper SOP class upon a user request to transmit images to the remote SCP. Storage-SCU initiates a new association for each new study. The association is terminated at the end of the transmission of the study.

2.2.2.3.1.1 Description and Sequencing of Activities

The SOP Instances are retrieved from the mass storage devices and transmitted to the remote entities.

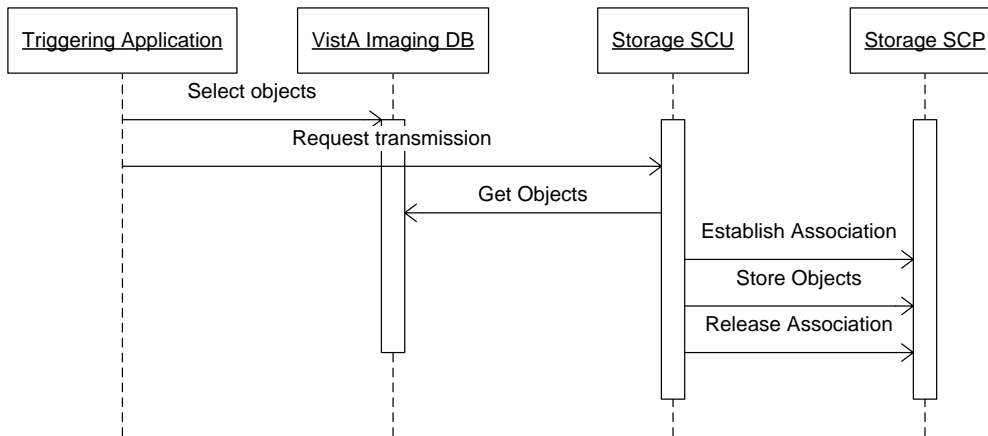

Figure 2-7: Storage-SCU: Sequencing of Activity

2.2.2.3.1.2 Proposed Presentation Contexts

The following table lists the Presentation Contexts proposed by Storage-SCU for storing SOP instances.

Table 2-14: Storage-SCU: Proposed Presentation Contexts

Presentation Context Table					
Abstract Syntax		Transfer Syntax		Role	Extended Negotiation
Name	UID	Name List	UID List		
Verification SOP Class	1.2.840.10008.1.1	Implicit VR Little Endian Explicit VR Little Endian Explicit VR Big Endian	1.2.840.10008.1.2 1.2.840.10008.1.2.1 1.2.840.10008.1.2.2	SCU	None
Computed Radiography Image Storage	1.2.840.10008.5.1.4.1.1.1	Implicit VR Little Endian Explicit VR Little Endian JPEG Lossy Baseline (Process 1) JPEG Lossless, Non-Hierarchical (Process 14)	1.2.840.10008.1.2 1.2.840.10008.1.2.1 1.2.840.10008.1.2.4.50 1.2.840.10008.1.2.4.57	SCU	None
Digital X-Ray Image Storage - For Presentation	1.2.840.10008.5.1.4.1.1.1.1	Implicit VR Little Endian Explicit VR Little Endian JPEG Lossy Baseline (Process 1) JPEG Lossless, Non-Hierarchical (Process 14)	1.2.840.10008.1.2 1.2.840.10008.1.2.1 1.2.840.10008.1.2.4.50 1.2.840.10008.1.2.4.57	SCU	None
Digital X-Ray Image Storage - For Processing	1.2.840.10008.5.1.4.1.1.1.1.1	Implicit VR Little Endian Explicit VR Little Endian	1.2.840.10008.1.2 1.2.840.10008.1.2.1	SCU	None

NETWORKING

Presentation Context Table					
Abstract Syntax		Transfer Syntax		Role	Extended Negotiation
Name	UID	Name List	UID List		
Digital Mammography X-Ray Image Storage - For Presentation	1.2.840.10008.5.1.4.1.1.1.2	Implicit VR Little Endian Explicit VR Little Endian	1.2.840.10008.1.2 1.2.840.10008.1.2.1	SCU	None
Digital Mammography X-Ray Image Storage - For Processing	1.2.840.10008.5.1.4.1.1.1.2.1	Implicit VR Little Endian Explicit VR Little Endian	1.2.840.10008.1.2 1.2.840.10008.1.2.1	SCU	None
Digital Intra-oral X-Ray Image Storage - For Presentation	1.2.840.10008.5.1.4.1.1.1.3	Implicit VR Little Endian Explicit VR Little Endian JPEG Lossy Baseline (Process 1) JPEG Lossless, Non-Hierarchical (Process 14)	1.2.840.10008.1.2 1.2.840.10008.1.2.1 1.2.840.10008.1.2.4.50 1.2.840.10008.1.2.4.57	SCU	None
Digital Intra-oral X-Ray Image Storage - For Processing	1.2.840.10008.5.1.4.1.1.1.3.1	Implicit VR Little Endian Explicit VR Little Endian	1.2.840.10008.1.2 1.2.840.10008.1.2.1	SCU	None
CT Image Storage	1.2.840.10008.5.1.4.1.1.2	Implicit VR Little Endian Explicit VR Little Endian JPEG Lossy Baseline (Process 1) JPEG Lossless, Non-Hierarchical (Process 14)	1.2.840.10008.1.2 1.2.840.10008.1.2.1 1.2.840.10008.1.2.4.50 1.2.840.10008.1.2.4.57	SCU	None
Ultrasound Multi-frame Image Storage (Retired)	1.2.840.10008.5.1.4.1.1.3	Implicit VR Little Endian Explicit VR Little Endian JPEG Lossy Baseline (Process 1) JPEG Lossless, Non-Hierarchical (Process 14)	1.2.840.10008.1.2 1.2.840.10008.1.2.1 1.2.840.10008.1.2.4.50 1.2.840.10008.1.2.4.57	SCU	None
Ultrasound Multi-frame Image Storage	1.2.840.10008.5.1.4.1.1.3.1	Implicit VR Little Endian Explicit VR Little Endian JPEG Lossy Baseline (Process 1) JPEG Lossless Non-Hierarchical (Process 14)	1.2.840.10008.1.2 1.2.840.10008.1.2.1 1.2.840.10008.1.2.4.50 1.2.840.10008.1.2.4.57	SCU	None
MR Image Storage	1.2.840.10008.5.1.4.1.1.4	Implicit VR Little Endian Explicit VR Little Endian JPEG Lossy Baseline (Process 1) JPEG Lossless, Non-Hierarchical (Process 14)	1.2.840.10008.1.2 1.2.840.10008.1.2.1	SCU	None
Nuclear Medicine Image Storage (Retired)	1.2.840.10008.5.1.4.1.1.5	Implicit VR Little Endian Explicit VR Little Endian JPEG Lossy Baseline (Process 1) JPEG Lossless, Non-Hierarchical (Process 14)	1.2.840.10008.1.2 1.2.840.10008.1.2.1 1.2.840.10008.1.2.4.50 1.2.840.10008.1.2.4.57	SCU	None

Presentation Context Table					
Abstract Syntax		Transfer Syntax		Role	Extended Negotiation
Name	UID	Name List	UID List		
Ultrasound Image Storage (Retired)	1.2.840.10008.5.1.4.1.1.6	Implicit VR Little Endian Explicit VR Little Endian	1.2.840.10008.1.2 1.2.840.10008.1.2.1 1.2.840.10008.1.2.4.50 1.2.840.10008.1.2.4.57	SCU	None
Ultrasound Image Storage	1.2.840.10008.5.1.4.1.1.6.1	Implicit VR Little Endian Explicit VR Little Endian JPEG Lossy Baseline (Process 1) JPEG Lossless Non-Hierarchical (Process 14)	1.2.840.10008.1.2 1.2.840.10008.1.2.1 1.2.840.10008.1.2.4.50 1.2.840.10008.1.2.4.57	SCU	None
Secondary Capture Image Storage	1.2.840.10008.5.1.4.1.1.7	Implicit VR Little Endian Explicit VR Little Endian JPEG Lossy Baseline (Process 1) JPEG Lossless Non-Hierarchical (Process 14)	1.2.840.10008.1.2 1.2.840.10008.1.2.1 1.2.840.10008.1.2.4.50 1.2.840.10008.1.2.4.57	SCU	None
Multi-frame Grayscale Byte Secondary Capture Image Storage	1.2.840.10008.5.1.4.1.1.7.2	Implicit VR Little Endian Explicit VR Little Endian JPEG Lossy Baseline (Process 1) JPEG Lossless Non-Hierarchical (Process 14)	1.2.840.10008.1.2 1.2.840.10008.1.2.1 1.2.840.10008.1.2.4.50 1.2.840.10008.1.2.4.57	SCU	None
Multi-frame Grayscale Word Secondary Capture Image Storage	1.2.840.10008.5.1.4.1.1.7.3	Implicit VR Little Endian Explicit VR Little Endian JPEG Lossy Baseline (Process 1) JPEG Lossless Non-Hierarchical (Process 14)	1.2.840.10008.1.2 1.2.840.10008.1.2.1 1.2.840.10008.1.2.4.50 1.2.840.10008.1.2.4.57	SCU	None
Multi-frame True Color Secondary Capture Image Storage	1.2.840.10008.5.1.4.1.1.7.4	Implicit VR Little Endian Explicit VR Little Endian JPEG Lossy Baseline (Process 1) JPEG Lossless Non-Hierarchical (Process 14)	1.2.840.10008.1.2 1.2.840.10008.1.2.1 1.2.840.10008.1.2.4.50 1.2.840.10008.1.2.4.57	SCU	None
X-Ray Angiographic Image Storage	1.2.840.10008.5.1.4.1.1.12.1	Implicit VR Little Endian Explicit VR Little Endian JPEG Lossy Baseline (Process 1) JPEG Lossless Non-Hierarchical (Process 14)	1.2.840.10008.1.2 1.2.840.10008.1.2.1 1.2.840.10008.1.2.4.50 1.2.840.10008.1.2.4.57	SCU	None
X-Ray Radiofluoroscopic Image Storage	1.2.840.10008.5.1.4.1.1.12.2	Implicit VR Little Endian Explicit VR Little Endian JPEG Lossy Baseline (Process 1) JPEG Lossless Non-Hierarchical (Process 14)	1.2.840.10008.1.2 1.2.840.10008.1.2.1 1.2.840.10008.1.2.4.50 1.2.840.10008.1.2.4.57	SCU	None

NETWORKING

Presentation Context Table					
Abstract Syntax		Transfer Syntax		Role	Extended Negotiation
Name	UID	Name List	UID List		
Nuclear Medicine Image Storage	1.2.840.10008.5.1.4.1.1.20	Implicit VR Little Endian Explicit VR Little Endian JPEG Lossy Baseline (Process 1) JPEG Lossless Non-Hierarchical (Process 14)	1.2.840.10008.1.2 1.2.840.10008.1.2.1 1.2.840.10008.1.2.4.50 1.2.840.10008.1.2.4.57	SCU	None
VL Image Storage (Retired)	1.2.840.10008.5.1.4.1.1.77.1	Implicit VR Little Endian Explicit VR Little Endian JPEG Lossy Baseline (Process 1) JPEG Lossless Non-Hierarchical (Process 14)	1.2.840.10008.1.2 1.2.840.10008.1.2.1 1.2.840.10008.1.2.4.50 1.2.840.10008.1.2.4.57	SCU	None
VL Endoscopic Image Storage SOP Class	1.2.840.10008.5.1.4.1.1.77.1.1	Implicit VR Little Endian Explicit VR Little Endian JPEG Lossy Baseline (Process 1) JPEG Lossless Non-Hierarchical (Process 14)	1.2.840.10008.1.2 1.2.840.10008.1.2.1 1.2.840.10008.1.2.4.50 1.2.840.10008.1.2.4.57	SCU	None
VL Microscopic Image Storage SOP Class	1.2.840.10008.5.1.4.1.1.77.1.2	Implicit VR Little Endian Explicit VR Little Endian JPEG Lossy Baseline (Process 1) JPEG Lossless Non-Hierarchical (Process 14)	1.2.840.10008.1.2 1.2.840.10008.1.2.1 1.2.840.10008.1.2.4.50 1.2.840.10008.1.2.4.57	SCU	None
VL Slide-Coordinates Microscopic Image Storage	1.2.840.10008.5.1.4.1.1.77.1.3	Implicit VR Little Endian Explicit VR Little Endian JPEG Lossy Baseline (Process 1) JPEG Lossless Non-Hierarchical (Process 14)	1.2.840.10008.1.2 1.2.840.10008.1.2.1 1.2.840.10008.1.2.4.50 1.2.840.10008.1.2.4.57	SCU	None
VL Photographic Image Storage SOP Class	1.2.840.10008.5.1.4.1.1.77.1.4	Implicit VR Little Endian Explicit VR Little Endian JPEG Lossy Baseline (Process 1) JPEG Lossless Non-Hierarchical (Process 14)	1.2.840.10008.1.2 1.2.840.10008.1.2.1 1.2.840.10008.1.2.4.50 1.2.840.10008.1.2.4.57	SCU	None
Ophthalmic Photography 8 Bit Image Storage	1.2.840.10008.5.1.4.1.1.77.1.5.1	Implicit VR Little Endian Explicit VR Little Endian JPEG Lossy Baseline (Process 1) JPEG Lossless Non-Hierarchical (Process 14)	1.2.840.10008.1.2 1.2.840.10008.1.2.1 1.2.840.10008.1.2.4.50 1.2.840.10008.1.2.4.57	SCU	None
Ophthalmic Photography 16 Bit Image Storage	1.2.840.10008.5.1.4.1.1.77.1.5.2	Implicit VR Little Endian Explicit VR Little Endian JPEG Lossy Baseline (Process 1) JPEG Lossless Non-Hierarchical (Process 14)	1.2.840.10008.1.2 1.2.840.10008.1.2.1 1.2.840.10008.1.2.4.50 1.2.840.10008.1.2.4.57	SCU	None

Presentation Context Table					
Abstract Syntax		Transfer Syntax		Role	Extended Negotiation
Name	UID	Name List	UID List		
VL Multi-frame Image Storage (Retired)	1.2.840.10008.5.1.4.1.1.77.2	Implicit VR Little Endian Explicit VR Little Endian JPEG Lossy Baseline (Process 1) JPEG Lossless Non-Hierarchical (Process 14)	1.2.840.10008.1.2 1.2.840.10008.1.2.1 1.2.840.10008.1.2.4.50 1.2.840.10008.1.2.4.57	SCU	None
Encapsulated PDF Storage SOP Class	1.2.840.10008.5.1.4.1.1.104.1	Implicit VR Little Endian Explicit VR Little Endian	1.2.840.10008.1.2 1.2.840.10008.1.2.1	SCU	None
Positron Emission Tomography Image Storage	1.2.840.10008.5.1.4.1.1.128	Implicit VR Little Endian Explicit VR Little Endian JPEG Lossy Baseline (Process 1) JPEG Lossless Non-Hierarchical (Process 14)	1.2.840.10008.1.2 1.2.840.10008.1.2.1 1.2.840.10008.1.2.4.50 1.2.840.10008.1.2.4.57	SCU	None

2.2.2.3.1.3 SOP Specific Conformance: Storage SOP Classes

The system offers no specialization for any of the SOP classes supported by Storage-SCU. No extended negotiation is supported.

The storage SOP Instances for each IOD will not include any added optional data elements with respect to the original dataset.

Storage-SCU does not make use of any privately-defined Functional Groups (private elements) for multiframe IODs that support Functional Groups.

Storage-SCU does not use C-STORE operations that use any referenced pixel data transfer syntax.

Storage-SCU responds to status messages from an SCP as follows:

Table 2-15: Storage-SCU: C-STORE Response Status

Service Status	Further Meaning	Status Codes	Behavior
Refused	Out of Resources	A7xx	SCU will retry in 15-minute intervals until successful or until user intervenes.
Error	Data Set does not match SOP Class	A9xx	Ignored.
	Cannot understand	Cxxx	SCU will retry in 15-minute intervals until successful or until user intervenes.
Warning	Coercion of Data Elements	B000	Ignored.
	Data Set does not match SOP Class	B007	SCU will retry in 15-minute intervals until successful or

Service Status	Further Meaning	Status Codes	Behavior
			until user intervenes.
	Elements Discarded	B006	Ignored.
Success		0000	

2.2.2.4 Association Acceptance Policy

Storage-SCU does not accept associations.

2.2.3 Modality-Worklist-SCP AE Specification

2.2.3.1 SOP Classes

The Modality-Worklist-SCP Application Entity provides Standard Conformance to the following SOP Classes:

Table 2-16: Modality-Worklist-SCP: Supported SOP Classes

SOP Class Name	SOP Class UID	SCU	SCP
Verification SOP Class	1.2.840.10008.1.1	No	Yes
Modality Worklist Information Model - FIND	1.2.840.10008.5.1.4.31	No	Yes

Modality-Worklist-SCP implements the data model described in the ER diagram in Annex K.2 of PS3.4-2009. Modality-Worklist-SCP provides information with the basic granularity of the Scheduled Procedure Steps.

2.2.3.2 Association Policies

2.2.3.2.1 General

The maximum PDU size offered is 32768 bytes. SOP Class Extended Negotiation is not supported. The DICOM standard Application context shall be specified.

Table 2-17: Modality-Worklist-SCP: DICOM Application Context

Application Context Name	1.2.840.10008.3.1.1.1
--------------------------	-----------------------

2.2.3.2.2 Number of Associations

Table 2-18: Modality-Worklist-SCP: Number of Associations Accepted

Maximum number of simultaneous Associations	1 - 25*
---	---------

*The maximum number of simultaneous associations is limited by database licenses and operating system resources.

2.2.3.2.3 Asynchronous Nature

Modality-Worklist-SCP does not support asynchronous communication (multiple transactions over a single Association).

Table 2-19: Modality-Worklist-SCP: Asynchronous Nature

Maximum number of outstanding asynchronous transactions	1
---	---

2.2.3.2.4 Implementation Identifying Information

The implementation information for Modality-Worklist-SCP is:

Table 2-20: Modality-Worklist-SCP: DICOM Implementation Class and Version

Implementation Class UID	1.2.840.113754.2.1.3.0
Implementation Version Name	VA DICOM V3.0

2.2.3.3 Association Initiation Policy

Modality-Worklist-SCP does not initiate Associations.

2.2.3.4 Association Acceptance Policy

Modality-Worklist-SCP accepts associations from any entity. However, Modality-Worklist-SCP will not recognize C-FIND requests from entities not included in the VistA “WorkList.dic” master file (i.e., not a trusted entity).

2.2.3.4.1 Activity – Receive and Respond to Modality Worklist Query

2.2.3.4.1.1 Description and Sequencing of Events

Modality-Worklist-SCP accepts an association from a remote SCU. If the SCU is a trusted entity, Modality-Worklist-SCP will respond to the Modality Worklist Query with the appropriate set of responses. The responses contain information defined by the return keys and the results are determined by the information conveyed by the matching keys of the C-FIND request. Access to the worklist does not grant claim to ownership of any of the worklist items; multiple acquisition devices may use the same Scheduled Procedure Step.

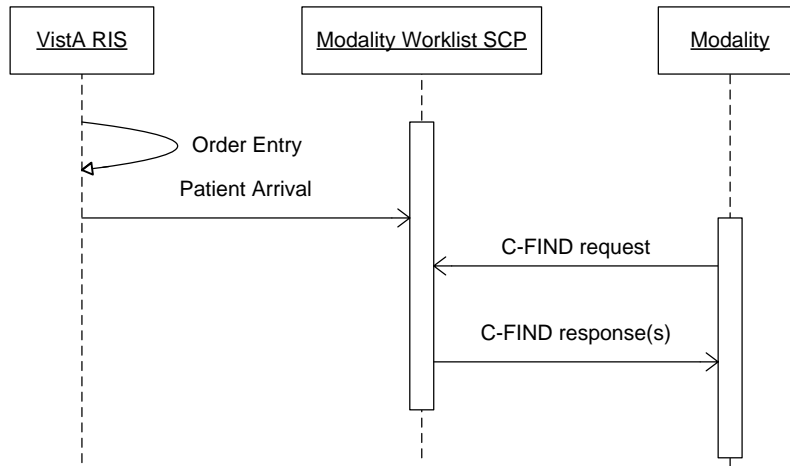

Figure 2-8: Modality-Worklist-SCP: Sequencing of Activity

2.2.3.4.1.2 Accepted Presentation Contexts

Table 2-21: Modality-Worklist-SCP: Accepted Presentation Contexts

Presentation Context Table					
Abstract Syntax		Transfer Syntax		Role	Extended Negotiation
Name	UID	Name List	UID List		
Verification SOP Class	1.2.840.10008.1.1	Implicit VR Little Endian Explicit VR Little Endian Explicit VR Big Endian	1.2.840.10008.1.2 1.2.840.10008.1.2.1 1.2.840.10008.1.2.2	SCP	None
Modality Worklist Information Model - FIND	1.2.840.10008.5.1.4.31	Implicit VR Little Endian	1.2.840.10008.1.2	SCP	None

Modality-Worklist-SCP does not support extended negotiation.

2.2.3.4.1.3 SOP Specific Conformance: Modality Worklist Information Model – FIND

There are different ways that image-producing equipment can obtain patient and study information from the Modality-Worklist-SCP AE. While the same DIMSE-C C-FIND command is used to obtain the data in any scenario, different capabilities are needed in the Modality-Worklist-SCP AE to handle the different situations that occur in the hospital information system environment:

Example 1 - Current Radiology Study

A technologist wants to obtain patient and study information on a currently active radiology study. The radiology information system software is sufficiently developed to output event transactions that signal the patient's arrival in the radiology department, as well as the completion of the examination. These events are used to dynamically populate and prune a small database, which is used to support the classic Modality Worklist provider.

The technologist can obtain the patient and study information for a single case either by entering the Accession Number or Case Number as the Requested Procedure ID. The technologist can also obtain the entire set of active patients and studies for the modality, and then pick the case from the list.

Example 2 – Prior Radiology Study

It is sometimes necessary to scan film of a previous radiology study. In this situation, the Radiology Information system does not generate any event transactions that can be used to update the classic Modality Worklist provider database. Nonetheless, given the Accession Number of the previous study, the VistA Modality Worklist provider can obtain the information about the study directly from the radiology information system database.

Example 3 – Current Clinical Specialty Study

VistA Imaging supports Clinical Specialty image producing DICOM modalities. The VistA HIS CPRS Consult Request Tracking package generates internal event transactions about clinical specialty imaging examinations. Given the Patient ID, the VistA Modality Worklist provider can obtain appropriate information about the study from the specific application database within the hospital information system. The VA standard Short ID may be used for the Patient ID in the Modality Worklist query. The Short ID consists of the initial of the patient's last name and the last four digits of the patient's medical record number (usually the patient's social security number). The Accession Number is almost never used in the Clinical Specialties as a Modality Worklist Query Key. (The Modality-Worklist-SCP does not support queries for prior non-radiology studies.)

The irregularity in the use of the VA Appointment Management package causes the scheduling information in the DICOM Modality Worklist database to be unreliable, and we recommend vendors to not rely on Scheduled Procedure Step Start Date (0040,0002) Modality Worklist queries.

These three examples demonstrate the support of the Accession Number and Requested Procedure ID query capability of Modality Worklist.

The ability to retrieve an entire Worklist of current studies for a modality is also supported.

Modality-Worklist-SCP will use the Calling AE Title of the remote SCU to appropriately identify the subset of Scheduled Procedure Steps for the class (radiology, ophthalmology, dentistry, etc.) of the modality issuing the request.

The timing of the Modality Worklist query is very important

- In radiology, the staff takes responsibility for the study and registers the patient in the department. This produces the “arrival event”. Because of the way the VA’s radiology information system works, the “arrival event” is the first notification that a Modality Worklist provider receives about a study. The most efficient use of Modality Worklist would be to perform a single query from the image producing device shortly after the patient has been registered. A query prior to the arrival event produces zero results.
- In the clinical specialties, an entry is created in the Modality Worklist as soon as the consult or procedure request is ordered. It is removed when the consult or procedure request is completed with the entry of electronically signed result text.

Frequently querying the Modality Worklist provider (i.e., “polling”) to retrieve patient data has proven to be inefficient. It is therefore strongly discouraged as the primary method for obtaining such data.

2.2.3.4.1.3.1 C-FIND Attributes

Modality-Worklist-SCP, in its role as a Basic Modality Worklist SCP, supports queries where the Accession Number (0008,0050) or Requested Procedure ID (0040,1001) are the only Matching Key attributes of the C-FIND Request². If a query contains only the Accession Number or the Requested Procedure ID as a Matching Key, only Single Value Matching is supported. If wildcard matching is used in the query, no results are returned.

Accession Number or Requested Procedure ID queries can produce identical results because the relationship between the Imaging Service Request (aka Accession Number) and the Requested Procedure is 1:1 in the VistA database. Queries containing either argument can be used interchangeably. The Accession Number can be used for the value of either field in either query request. The SCP will always return the Accession Number in the Accession Number Return Key attribute and Case Number in the Requested Procedure ID Return Key attribute.³

Modality-Worklist-SCP assumes all attributes with a VR of PN are case insensitive. Extended negotiation of fuzzy semantic matching of person names is not supported.

² This is consistent with the requirements stated in revision 8.0 of the IHE *Radiology Technical Framework*, available at www.ihe.net/Technical_Framework/index.cfm.

³ Note that the value in the query request may be in a different format than the value returned in the query response.

Modality-Worklist-SCP uses the default character set of ISO-IR 6 in the Specific Character Set tag (0008,0005) when interpreting queries, performing matching, and encoding responses.

The table below specifies the Matching and Return Key attributes showing the mapping from VistA data elements.

Table 2-22: Modality-Worklist-SCP: Attributes for the Modality Worklist Information Model

Description/Module	VistA Name	Tag	Match Key	Return Key
Scheduled Procedure Step				
Scheduled Procedure Step Sequence		(0040,0100)	--	✓
>Modality	Modality	(0008,0060)	✓	✓
>Scheduled Station AE Title		(0040,0001)	✓	✓
>Scheduled Procedure Step Start Date		(0040,0002)	✓	✓
>Scheduled Procedure Step Start Time		(0040,0003)	✓	✓
>Scheduled Performing Physician's Name	Technologist / Physician performing the study	(0040,0006)	✓	✓
>Scheduled Procedure Step description	VA Procedure Description	(0040,0007)	--	✓
>Scheduled Protocol Code Sequence	VA Procedure ⁴	(0040,0008)	--	✓
>>Code Value	VA Procedure Code (IEN)	(0008,0100)	--	✓
>>Coding Scheme Designator	VA Coding Scheme (L)	(0008,0102)	--	✓
>>Code Meaning	VA Procedure Description	(0008,0104)	--	✓
>Scheduled Procedure Step ID		(0040,0009)	--	✓
>>Scheduled Procedure Step Location	Room location for study	(0040,0011)	--	✓
>>Scheduled Procedure Step Status	Study Status	(0040,0020)	--	✓
Requested Procedure				
Study Description	VA Procedure Description	(0008,1030)	--	✓
Study ID	Case Number	(0020,0010)	--	✓
Study Instance UID	Study SOP Instance UID	(0020,000D)	✓	✓

⁴ The Scheduled Action Item Code Sequence contains the VA (local) procedure codes, to be compatible with IHE.

NETWORKING

Description/Module	VistA Name	Tag	Match Key	Return Key
Requested Procedure Description	CPT Procedure Description	(0032,1060)	--	✓
Requested Procedure Code Sequence	CPT Procedure	(0032,1064)	--	✓
>Code Value	CPT Procedure Code	(0008,0100)	--	✓
>Coding Scheme Designator	CPT Coding Scheme (C4)	(0008,0102)	--	✓
>Code Meaning	CPT Procedure Description	(0008,0104)	--	✓
Requested Procedure ID	Case Number	(0040,1001)	✓	✓
Reason for the Requested Procedure	VA's Reason For The Study	(0040,1002)	--	✓
Requested Procedure Priority	Requested Procedure Priority	(0040,1003)	--	✓
Confidentiality Code	Confidentiality Code	(0040,1008)	--	✓
Names of Intended recipients of results	Attending Physician	(0040,1010)	--	✓
Requested Procedure Comments	<i>To be used as needed</i>	(0040,1400)	--	✓
Imaging Service Request				
Accession Number	Accession Number	(0008,0050)	✓	✓
Referring Physician's Name	Primary Care Provider	(0008,0090)	--	✓
Requesting Physician	Ordering Physician	(0032,1032)	--	✓
Requesting Service	Requesting Service	(0032,1033)	--	✓
Order Callback Phone Number	Order Callback Phone Number	(0040,2010)	--	✓
Imaging Service Request Comments	<i>To be used as needed</i>	(0040,2400)	--	✓
Visit Identification				
Institution Name	Institution Name	(0008,0080)	--	✓
Admission ID	Admission ID	(0038,0010)	--	✓
Visit Status				
Current Patient Location	Patient Location	(0038,0300)	--	✓
Patient's Institution Residence	Patient's Institution Residence	(0038,0400)	--	✓
Visit Comments	In/Out Patient	(0038,4000)	--	✓
Visit Admission				
Admitting Date	Admitting Date	(0038,0020)	--	✓

Description/Module	VistA Name	Tag	Match Key	Return Key
Admitting Time	Admitting Time	(0038,0021)	--	✓
Patient Identification				
Patient's Name	Patient Name	(0010,0010)	✓	✓
Patient ID	Patient ID	(0010,0020)	✓	✓
Issuer of Patient ID	<i>No VistA Name</i>	(0010,0021)	--	✓
Other Patient IDs	Multiple: <ICN> (Integration Control Number) as the first value, and <VA station number>-<DFN> as the second value.	(0010,1000)	--	✓
Patient Demographic				
Patients Birth Date	Patient Date of Birth	(0010,0030)	--	✓
Patient's Sex	Patient Sex	(0010,0040)	--	✓
Patient's Size	Height	(0010,1020)	--	✓
Patient's Weight	Patient's Weight	(0010,1030)	--	✓
Patient's Address	Patient Address	(0010,1040)	--	✓
Ethnic Group	Patient Race	(0010,2160)	--	✓
Patient Comment	Patient Comment (Lab Data / Problem List / Most Recent Discharge Summary/ Progress Notes)	(0010,4000)	--	✓
Confidentiality constraint on patient data	Confidentiality constraint on patient data	(0040,3001)	--	✓

Description/Module	VistA Name	Tag	Match Key	Return Key
Patient Medical				
Medical Alerts	Allergies	(0010,2000)	--	✓
Additional Patient History ⁵	Reason for Study (history)	(0010,21B0)	--	✓
Pregnancy Status	Pregnancy Status	(0010,21C0)	--	✓
Study Scheduling				
Reason For Study	Reason For Study	(0032,1030)	--	✓
Study Classification				
Study Comments	Technology Comment	(0032,4000)	--	✓
Image Acquisition Results				
Performing Physician's Name	Attending Physician	(0008,1050)	--	✓

2.2.3.4.1.3.2 Response Status

Modality-Worklist-SCP behaves as described below in response to a C-FIND command.

Table 2-23: Modality-Worklist-SCP: C-FIND Response Status

Service Status	Further Meaning	Status Codes	Behavior
Refused	Out of Resources	A7xx	Return response message with no data set and log details.
Error	Data Set does not match SOP Class	A9xx	Never sent – data set is not checked prior to response
	Cannot understand	Cxxx	Never sent
Warning	Coercion of Data Elements	B000	Never sent – no coercion is ever performed
	Data Set does not match SOP Class	B007	Never sent – data set is not checked prior to response
	Elements Discarded	B006	Never sent – all elements are always received
Pending	Matching is	FF00	Return response message containing single data set

⁵ In the VA HIS/RIS the reason for the study is often a short patient history summarizing the condition of the patient and giving background information for the reason for the study. It usually exceeds the 64 character Long String Value Representation provided by the DICOM standard attributes Reason for the Study (0032,1030), Reason for the Requested Procedure (0040,1002), and Reason of the Imaging Service Request (0040,2001). In order to faithfully communicate this essential field, the VA has chosen to map it to the Additional Patient History (0010,21B0) attribute.

Service Status	Further Meaning	Status Codes	Behavior
	continuing		record
Success	Matching is complete	0000	Return response message containing final status with no data set record

2.2.4 Modality-Worklist-SCU AE Specification

2.2.4.1 SOP Classes

The Modality-Worklist-SCU Application Entity provides Standard Conformance to the following SOP Class:

Table 2-24: Modality-Worklist-SCU: Supported SOP Classes

SOP Class Name	SOP Class UID	SCU	SCP
Modality Worklist Information Model - FIND	1.2.840.10008.5.1.4.31	Yes	No

2.2.4.2 Association Policies

2.2.4.2.1 General

The maximum PDU size offered is 32768 bytes. SOP Class Extended Negotiation is not supported. The DICOM standard Application context shall be specified.

Table 2-25: Modality-Worklist-SCU: DICOM Application Context

Application Context Name	1.2.840.10008.3.1.1.1
--------------------------	-----------------------

2.2.4.2.2 Number of Associations

Table 2-26: Modality-Worklist-SCU: Number of Associations Accepted

Maximum number of simultaneous Associations	1
---	---

2.2.4.2.3 Asynchronous Nature

Modality-Worklist-SCU does not support asynchronous communication (multiple transactions over a single Association).

Table 2-27: Modality-Worklist-SCU: Asynchronous Nature

Maximum number of outstanding asynchronous transactions	1
---	---

2.2.4.2.4 Implementation Identifying Information

The implementation information for Modality-Worklist -SCU is:

Table 2-28: Modality-Worklist-SCU: DICOM Implementation Class and Version

Implementation Class UID	1.2.840.113754.2.1.3.0
Implementation Version Name	VA DICOM V3.0

2.2.4.3 Association Initiation Policy

Modality-Worklist-SCU establishes a single association upon user request.

2.2.4.3.1 Activity—Issue Modality Worklist Query

2.2.4.3.1.1 Description and Sequencing of Activities

The user request is initiated by executing a menu option which initiates the association, which in turn is used to send the C-FIND request and receive the C-FIND responses generated by the SCP.

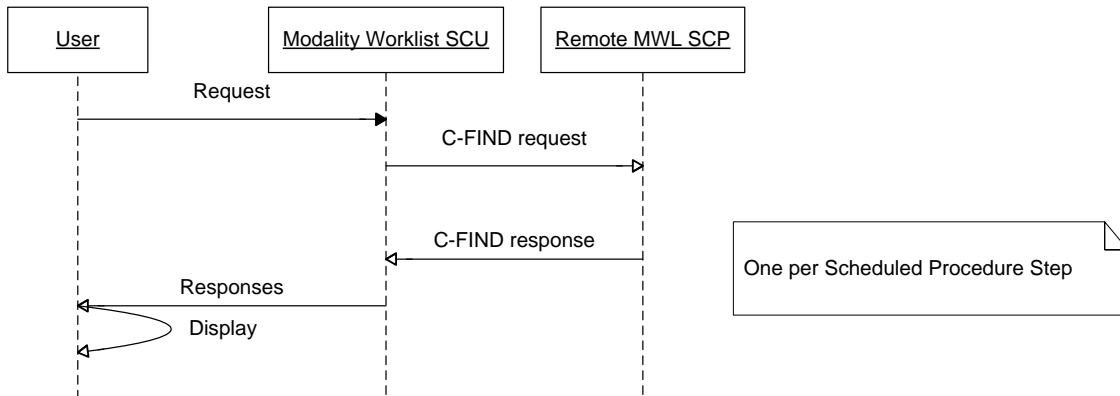

Figure 2-9: Modality-Worklist-SCU: Sequencing of Activity

2.2.4.3.1.2 Proposed Presentation Contexts

Table 2-29: Modality-Worklist-SCU: Proposed Presentation Contexts

Presentation Context Table					
Abstract Syntax		Transfer Syntax		Role	Extended Negotiation
Name	UID	Name List	UID List		
Modality Worklist Information Model - FIND	1.2.840.10008.5.1.4.31	Implicit VR Little Endian	1.2.840.10008.1.2	SCU	None

2.2.4.3.1.3 SOP Specific Conformance: Modality Worklist SOP Class

Extended negotiation of fuzzy semantic matching of person names is not supported.

Modality-Worklist-SCU uses the default character set of ISO-IR 6 in the Specific Character Set tag (0008,0005) when generating queries.

Modality-Worklist-SCU inserts the following return and matching keys (✓) into the C-FIND request. The returned information is displayed on the user screen allowing the verification of the success or failure of the operation.

No optional matching attributes are supported by Modality-Worklist-SCU.

Table 2-30: Modality-Worklist-SCU: Attributes for the Modality Worklist Query

Description/ Module	VistA Name	Tag	Matching Key
Scheduled Procedure Step			
Scheduled Procedure Step Sequence		(0040,0100)	--
>Modality	Modality	(0008,0060)	✓
>Scheduled Station AE Title		(0040,0001)	--
>Scheduled Procedure Step Start Date		(0040,0002)	✓
>Scheduled Procedure Step Start Time		(0040,0003)	✓
>Scheduled Performing Physician's Name	Technologist / Physician performing the study	(0040,0006)	--
>Scheduled Procedure Step description	VA Procedure Description	(0040,0007)	--
>Scheduled Protocol Code Sequence	VA Procedure ⁶	(0040,0008)	--
>>Code Value	VA Procedure Code (IEN)	(0008,0100)	--
>>Coding Scheme Designator	VA Coding Scheme (L)	(0008,0102)	--
>>Code Meaning	VA Procedure Description	(0008,0104)	--
>Scheduled Procedure Step ID		(0040,0009)	--
>>Scheduled Procedure Step Location	Room location for study	(0040,0011)	--
>>Scheduled Procedure Step Status	Study Status	(0040,0020)	--
Requested Procedure			
Study Description	VA Procedure Description	0008,1030	--

⁶ The Scheduled Action Item Code Sequence contains the VA (local) procedure codes to be compatible with IHE.

NETWORKING

Description/ Module	VistA Name	Tag	Matching Key
Study ID	Case Number	(0020,0010)	--
Study Instance UID	Study SOP Instance UID	(0020,000D)	--
Requested Procedure Description	CPT Procedure Description	(0032,1060)	--
Requested Procedure Code Sequence	CPT Procedure	(0032,1064)	--
>Code Value	CPT Procedure Code	(0008,0100)	--
>Coding Scheme Designator	CPT Coding Scheme (C4)	(0008,0102)	--
>Code Meaning	CPT Procedure Description	(0008,0104)	--
Requested Procedure ID	Case Number	(0040,1001)	✓
Reason for the Requested Procedure	VA's Reason For The Study	(0040,1002)	--
Requested Procedure Priority	Requested Procedure Priority	(0040,1003)	--
Confidentiality Code	Confidentiality Code	(0040,1008)	--
Names of Intended recipients of results	Attending Physician	(0040,1010)	--
Requested Procedure Comments	<i>To be used as needed</i>	(0040,1400)	--
Imaging Service Request			
Accession Number	Accession Number	(0008,0050)	✓
Referring Physician's Name	Primary Care Provider	(0008,0090)	--
Requesting Physician	Ordering Physician	(0032,1032)	--
Requesting Service	Requesting Service	(0032,1033)	--
Order Callback Phone Number	Order Callback Phone Number	(0040,2010)	--
Imaging Service Request Comments	<i>To be used as needed</i>	(0040,2400)	--
Visit Identification			
Institution Name	Institution Name	(0008,0080)	--
Admission ID	Admission ID	(0038,0010)	--
Visit Status			
Current Patient Location	Patient Location	(0038,0300)	--
Patient's Institution Residence	Patient's Institution Residence	(0038,0400)	--
Visit Comments	In/Out Patient	(0038,4000)	--

Description/ Module	VistA Name	Tag	Matching Key
Visit Admission			
Admitting Date	Admitting Date	(0038,0020)	--
Admitting Time	Admitting Time	(0038,0021)	--
Patient Identification			
Patient's Name	Patient Name	(0010,0010)	✓
Patient ID	Patient ID	(0010,0020)	✓
Issuer of Patient ID	<i>No VistA Name</i>	(0010,0021)	--
Other Patient IDs	Multiple: <ICN> (Integration Control Number) as the first value, and <VA station number>-<DFN> as the second value.	(0010,1000)	--
Patient Demographic			
Patients Birth Date	Patient Date of Birth	(0010,0030)	--
Patient's Sex	Patient Sex	(0010,0040)	--
Patient's Size	Height	(0010,1020)	--
Patient's Weight	Patient's Weight	(0010,1030)	--
Patient's Address	Patient Address	(0010,1040)	--
Ethnic Group	Patient Race	(0010,2160)	--
Patient Comment	Patient Comment (Lab Data / Problem List / Most Recent Discharge Summary/ Progress Notes)	(0010,4000)	--
Confidentiality constraint on patient data	Confidentiality constraint on patient data	(0040,3001)	
Patient Medical			
Medical Alerts	Allergies	(0010,2000)	--
Additional Patient History ⁷	Reason for Study (history)	(0010,21B0)	--

⁷ In the VistA HIS/RIS, "Reason for Study" is often a short patient history summarizing the condition of the patient and giving background information for the reason for the study. It usually exceeds the 64 character Long String Value Representation provided by the DICOM standard attributes Reason for the Study (0032,1030), Reason for the Requested Procedure (0040,1002), and Reason of the Imaging Service Request (0040,2001). In order to faithfully communicate this essential field, the VA has chosen to map it to the Additional Patient History (0010,21B0) attribute.

Description/ Module	VistA Name	Tag	Matching Key
Pregnancy Status	Pregnancy Status	(0010,21C0)	--
Study Scheduling			
Reason For Study	Reason For Study	(0032,1030)	--
Study Classification			
Study Comments	Technology Comment	(0032,4000)	--
Image Acquisition Results			
Performing Physician's Name	Attending Physician	(0008,1050)	--

Table 2-31: Modality-Worklist-SCU: C-FIND Response Handling

Service Status	Further Meaning	Status Codes	Behavior
Refused	Out of Resources	A7xx	Ignored
Error	Data Set does not match SOP Class	A9xx	Ignored
	Cannot understand	Cxxx	Ignored
Cancel	Cancel requested—matching terminated	FE00	Ignored
Pending	Matches are continuing	FF00	Waiting for additional responses
	Matches are continuing— one or more optional keys are not supported	FF01	Waiting for additional responses
Success		0000	Matching is complete

Modality-Worklist-SCU's behavior during communication failure is summarized below:

Table 2-32: Modality-Worklist-SCU: Communication Failure Behavior

Exception	Behavior
Timeout	The Association is aborted using A-ABORT and the worklist query marked as failed.
Association aborted	The worklist query is marked as failed.

2.2.4.4 Association Acceptance Policy

Modality-Worklist-SCU does not accept associations.

2.2.5 Query/Retrieve-SCP AE Specification

2.2.5.1 SOP Classes

The Query/Retrieve-SCP Application Entity provides Standard Conformance to the following SOP Class:

Table 2-33: Query/Retrieve-SCP: Supported SOP Classes

SOP Class Name	SOP Class UID	SCU	SCP
Verification	1.2.840.10008.1.1	No	Yes
Study Root Query/Retrieve Information Model - FIND	1.2.840.10008.5.1.4.1.2.2.1	No	Yes
Study Root Query/Retrieve Information Model - MOVE	1.2.840.10008.5.1.4.1.2.2.2	No	Yes

Only Study Level attributes are supported by Query/Retrieve-SCP.

2.2.5.2 Association Establishment Policies

2.2.5.2.1 General

The maximum PDU size offered is 32768 bytes. SOP Class Extended Negotiation is not supported. The DICOM standard Application context shall be specified.

Table 2-34: Query/Retrieve-SCP: DICOM Application Context

Application Context Name	1.2.840.10008.3.1.1.1
--------------------------	-----------------------

2.2.5.2.2 Number of Associations

Query/Retrieve-SCP can support multiple simultaneous Associations. The maximum number of simultaneous Associations that can be processed is set by configuration. The default maximum is 32.

Table 2-35: Query/Retrieve-SCP: Number of Associations Accepted

Maximum number of simultaneous Associations	32 (configurable)
---	-------------------

The maximum number of simultaneous Associations can be either an absolute number or a maximum number for each requesting external Application Entity. The latter flexibility can be useful if communication with one external AE is unreliable and one does not wish 'hung' connections with this AE to prevent Associations with other AEs.

2.2.5.2.3 Asynchronous Nature

Query/Retrieve-SCP does not support asynchronous communication (multiple transactions over a single Association).

Table 2-36: Query/Retrieve-SCP: Asynchronous Nature

Maximum number of outstanding asynchronous transactions	1
---	---

2.2.5.2.4 Implementation Identifying Information

The implementation information for Query/Retrieve-SCP is:

Table 2-37: Query/Retrieve-SCP: DICOM Implementation Class and Version

Implementation Class UID	1.2.840.113754.2.1.3.0
Implementation Version Name	VA DICOM V3.0

2.2.5.3 Association Initiation Policy

Query/Retrieve-SCP does not initiate Associations. When a C-MOVE request is received, Query/Retrieve-SCP instructs Storage-SCU to initiate an association and transmit images to the specified destination.

2.2.5.4 Association Acceptance Policy

Query/Retrieve-SCP accepts Associations for Verification, C-FIND, and C-MOVE requests. Query/Retrieve-SCP only accepts Associations from known Calling AE Titles.

2.2.5.4.1 Activity – Handling Query and Retrieval Requests

2.2.5.4.1.1 Description and Sequencing of Activity

Query/Retrieve-SCP only accepts Associations that have valid Presentation Contexts. If none of the requested Presentation Contexts are accepted, then the Association Request itself is rejected. Query/Retrieve-SCP can be configured to only accept Associations with certain hosts (using TCP/IP address) and Application Entity Titles.

If Query/Retrieve-SCP receives a query (C-FIND) request, responses are sent over the same Association used to send the C-FIND-Request.

If Query/Retrieve-SCP receives a retrieval (C-MOVE) request, responses are sent over the same Association used to send the C-MOVE-Request. The Query/Retrieve-SCP then notifies the Storage-SCU to send the requested SOP Instances to the C-MOVE destination. Storage-SCU notifies Query/Retrieve-SCP of the success or failure of each attempt to send a Composite SOP Instance to the peer C-MOVE Destination AE. Query/Retrieve-SCP then optionally sends a C-MOVE Response indicating this status

after each attempt. Once the Storage-SCU AE has finished attempting to transfer all the requested SOP Instances, Query/Retrieve-SCP sends a final C-MOVE Response indicating the overall status of the attempted retrieval.

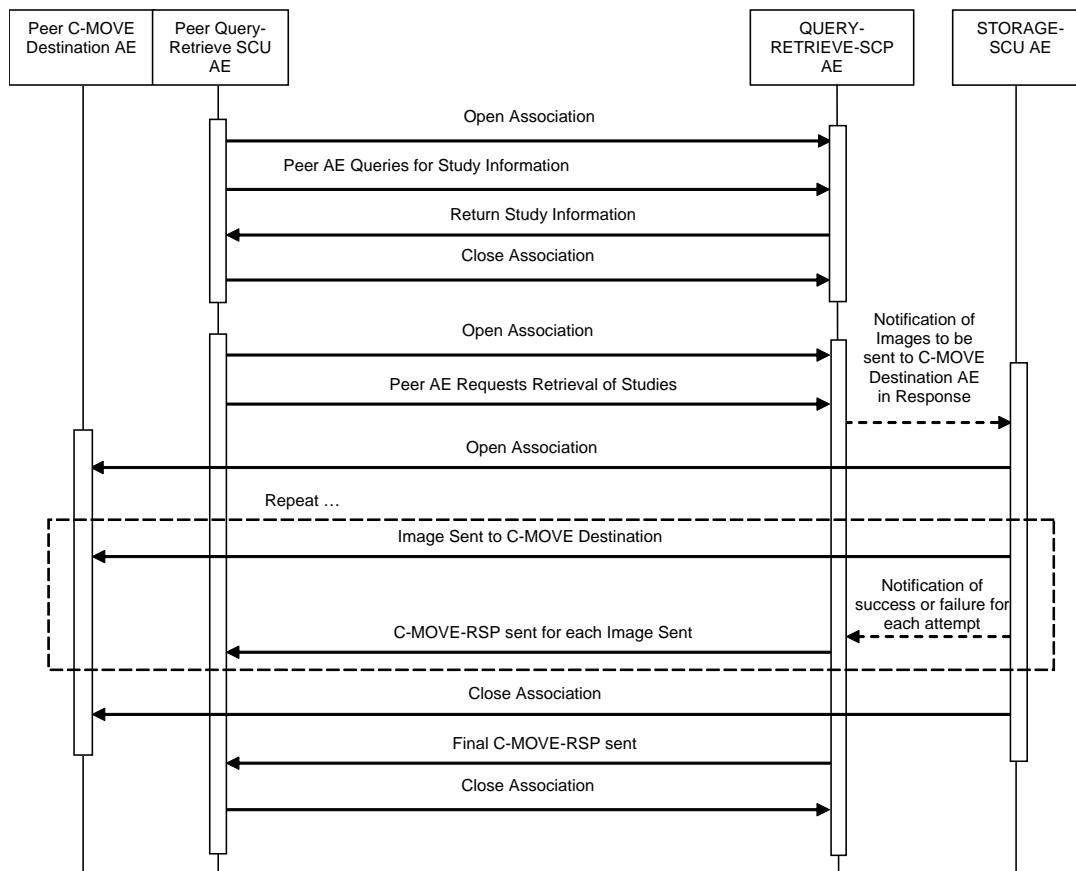

Figure 2-10: Query/Retrieve-SCP: Sequencing of Activity

For queries (C-FIND-Requests), the following sequencing constraints illustrated in the figure above apply to Query/Retrieve-SCP :

1. Peer AE opens an Association with Query/Retrieve-SCP.
2. Peer AE sends a C-FIND-RQ Message
3. Query/Retrieve-SCP returns a C-FIND-RSP Message to the peer AE with matching information. A C-FIND-RSP is sent for each entity matching the identifier specified in the C-FIND-RQ. A final C-FIND-RSP is sent indicating that matching is complete.
4. Peer AE closes the Association. Note that the peer AE does not have to close the Association immediately. Additional C-FIND or C-MOVE Requests can be sent over the Association before it is closed.

For retrievals (C-MOVE-Requests), the following sequencing constraints illustrated in the figure above apply to Query/Retrieve-SCP:

1. Peer AE opens an Association with Query/Retrieve-SCP.
2. Peer AE sends a C-MOVE-RQ Message
3. Query/Retrieve-SCP notifies the local Storage-SCU to send the Composite SOP Instances to the peer C-MOVE Destination AE as indicated in the C-MOVE-RQ.
4. After attempting to send a SOP Instance, Storage-SCU indicates to Query/Retrieve-SCP whether the transfer succeeded or failed. Query/Retrieve-SCP then optionally returns a C-MOVE-RSP indicating this success or failure.
5. Once Storage-SCU has completed all attempts to transfer the SOP Instances to the C-MOVE Destination AE, or once the first failure has occurred, Query/Retrieve-SCP sends a final C-MOVE-RSP indicating the overall success or failure of the retrieval.
6. Peer AE closes the Association. Note that the peer AE does not have to close the Association immediately. Additional C-FIND or C-MOVE Requests can be sent over the Association before it is closed.

Query/Retrieve-SCP may reject Association attempts as shown in the table below. The Result, Source and Reason/Diag columns represent the values returned in the corresponding fields of an ASSOCIATE-RJ PDU (see PS3.8-2009, Section 9.3.4).

Table 2-38: Query/Retrieve-SCP: Association Rejection Reasons

Result	Source	Reason/Diag.	Explanation
1 – rejected-permanent	1 – DICOM UL service-user	2 – application-context-name-not-supported	The Association request contained an unsupported Application Context Name. An association request with the same parameters will not succeed at a later time.
1 – rejected-permanent	1 – DICOM UL service-user	3 – calling-AE-title-not-recognized	The Association request contained an unrecognized Calling AE Title. An Association request with the same parameters will not succeed at a later time unless configuration changes are made. This rejection reason normally occurs when the Association acceptor has not been configured to recognize the AE Title of the Association initiator.
1 – rejected-permanent	1 – DICOM UL service-user	7 – called-AE-title-not-recognized	The Association request contained an unrecognized Called AE Title. An Association request with the same parameters will not succeed at a later time unless configuration changes are made. This rejection reason normally occurs when the Association initiator is incorrectly configured and attempts to address the Association acceptor using the wrong AE Title.
1 – rejected-permanent	2 – DICOM UL service-provider (ASCE-related function)	1 – no-reason-given	The Association request could not be parsed. An Association request with the same format will not succeed at a later time.

Result	Source	Reason/Diag.	Explanation
2 – rejected-transient	3 – DICOM UL service-provider (Presentation-related function)	1 – temporary-congestion	No Associations can be accepted at this time due to the real-time requirements of higher priority activities (e.g. during image acquisition no Associations will be accepted) or because insufficient resources are available (e.g. memory, processes, threads). An Association request with the same parameters may succeed at a later time.
2 – rejected-transient	3 – DICOM UL service-provider (Presentation-related function)	2 – local-limit-exceeded	The (configurable) maximum number of simultaneous Associations has been reached. An Association request with the same parameters may succeed at a later time.

2.2.5.4.1.2 Accepted Presentation Contexts

Query/Retrieve-SCP accepts Presentation Contexts as shown in the following table:

Table 2-39: Query/Retrieve-SCP: Accepted Presentation Contexts

Presentation Context Table						
Abstract Syntax		Transfer Syntax		Role	Ext Neg	Level
Name	UID	Name List	UID List			
Verification	1.2.840.10008.1.1	Implicit VR Little Endian Explicit VR Little Endian Explicit VR Big Endian	1.2.840.10008.1.2 1.2.840.10008.1.2.1 1.2.840.10008.1.2.2	SCP	None	n/a
Study Root Query/Retrieve Information Model - FIND	1.2.840.10008.5.1.4.1.2.2.1	Implicit VR Little Endian	1.2.840.10008.1.2	SCP	None	Study
Study Root Query/Retrieve Information Model - MOVE	1.2.840.10008.5.1.4.1.2.2.2	Implicit VR Little Endian	1.2.840.10008.1.2	SCP	None	Study

2.2.5.4.1.3 SOP Specific Conformance: Query SOP Classes

Query/Retrieve-SCP does not support hierarchical or relational queries. No attributes are returned by default. Only those attributes requested in the query identifier are returned. Exported SOP Instances are always updated with the latest values in the database prior to export. Thus, a change in Patient demographic information will be contained in both the C-FIND Responses and any Composite SOP Instances exported to a C-MOVE Destination AE.

The table below indicates the Matching Type and Modes expected by the remote C-FIND SCU.

S indicates the identifier attribute can specify Single Value Matching
r indicates Range Matching,

* indicates wildcard matching,

U indicates universal matching

UNIQUE indicates that this is the Unique Key for that query level, in which case Universal Matching or Single Value Matching is used depending on the scope of the query. ('L' would indicate that UID lists are supported for matching and "NONE" would indicate that no matching is required, but that values for this Element in the database can be returned.)

Table 2-40: Query/Retrieve-SCP: Study Root/Study Level Matching Keys

Description	Matching Type	Tag	Matching Mode
Query/Retrieve Level ("STUDY")	Required	(0008,0052)	S
Study Date	Required	(0008,0020)	S, r, U
Study Time	Required	(0008,0030)	r, U
Study ID	Required	(0020,0010)	S, *, U
Patient's Name	Required	(0010,0010)	S, *, U
Patient ID	Required	(0010,0020)	S, *, U
Accession Number	Required	(0008,0050)	S, *, U
Study Instance UID	UNIQUE	(0020,000D)	UNIQUE
Modalities in Study	Optional	(0008,0061)	S, *, U
Referring Physician's Name	Optional	(0008,0090)	S, *, U
Study Description	Optional	(0008,1030)	S, *, U
Procedure Code Sequence	Optional	(0008,1032)	S
>Code Value	Optional	(0008,0100)	S, U
>Coding Scheme Designator	Optional	(0008,0102)	U
>Coding Scheme Version	Optional	(0008,0103)	U
>Code Meaning	Optional	(0008,0104)	U
Name of Physician(s) Reading Study	Optional	(0008,1060)	S, *, U
Other Patient IDs	Optional	(0010,1000)	S, *, U
Other Patient Names	Optional	(0010,1001)	S, *, U
Patient's Age	Optional	(0010,1010)	U
Patient's Birth Date	Optional	(0010,0030)	S, *, U
Patient's Sex	Optional	(0010,0040)	S, *, U
Patient's Size (field not populated in production system)	Optional	(0010,1020)	S, *, U
Patient's Weight (field not populated in production system)	Optional	(0010,1030)	S, *, U
Ethnic Group	Optional	(0010,2160)	S, *, U
Interpretation Author	Optional	(4008,010C)	S, *, U

The table below indicates the responses sent to the remote C-FIND SCU.

Table 2-41: Query-Retrieve-SCP: C-FIND Response Status Return Behavior

Service Status	Further Meaning	Error Code	Behavior
Success	Success	0000	Matching is complete. No final identifier is supplied.
Refused	Out of Resources	A700	System reached the limit in disk space or memory usage. Error message is output to as an alert to the User Interface, and to the Service Log.
Failed	Identifier does not match SOP Class	A900	The C-FIND query identifier contains invalid Elements or values, or is missing mandatory Elements or values for the specified SOP Class. Error message is output to the Service Log.
	Unable to process	C001	The C-FIND query identifier is valid for the specified SOP Class but cannot be used to query the database. For example, this can occur if a Patient Level query is issued but the identifier has only empty values for both the Patient ID and the Patient Name. Error message is output to the Service Log.
Cancel	Matching terminated due to Cancel Request	FE00	The C-FIND SCU sent a Cancel Request. This has been acknowledged and the search for matches has been halted.
Pending	Matches are continuing and current match is supplied.	FF00	Indicates that the search for further matches is continuing. This is returned when each successful match is returned and when further matches are forthcoming. This status code is returned if all Optional keys in the query identifier are actually supported.
	Matches are continuing but one or more Optional Keys were not supported.	FF01	Indicates that the search for further matches is continuing. This is returned when each successful match is returned and when further matches are forthcoming. This status code is returned if there are Optional keys in the query identifier that are not supported.

2.2.5.4.1.4 SOP Specific Conformance: Retrieval SOP Classes

Query/Retrieve-SCP conveys to Storage-SCU that an Association with an AE named by the external C-MOVE SCU (through a MOVE Destination AE Title) should be established. It will also convey to Storage-SCU to perform C-STORE operations on specific images as requested by the remote C-MOVE SCU. One or more of the Image Storage Presentation Contexts listed Table 2-14 will be negotiated.

An initial C-MOVE Response is always sent after confirming that the C-MOVE Request itself can be processed. After this, based on configuration, Query/Retrieve-SCP may or may not return a response to the remote C-MOVE SCU after Storage-SCU has attempted to send each image. This response reports the number of remaining SOP Instances to transfer, and the number transferred having a successful, failed, or warning status. If the Composite SOP Instances must be retrieved from long-term archive prior to export there may be quite a long delay between the first C-MOVE Response and the next one after the attempt to export the first image.

Table 2-42: Query-Retrieve-SCP: C-MOVE Response Status Return Behavior

Service Status	Further Meaning	Error Code	Behavior
Success	Sub-operations complete – No Failures	0000	All the Composite SOP Instances have been successfully sent to the C-MOVE Destination AE.
Refused	Out of Resources – Unable to calculate number of matches	A701	Number of matches cannot be determined due to system failure. Returned if the server’s database is not functioning so the search for matches to the C-MOVE Request cannot be found. Error message is output as an alert on the User Interface, and to the Service Log.
	Out of Resources – Unable to perform sub-operations	A702	C-STORE sub-operations cannot be performed due to failure to access Composite SOP Instances in archive, or failure of a C-STORE Request. For example, this Status will be returned if the required SOP Instances are determined to be off-line (i.e. the MO media has been removed from the archive jukebox). Error message is output as an alert on the User Interface, and to the Service Log.
	Move destination unknown	A801	The Destination Application Entity named in the C-MOVE Request is unknown to Query-Retrieve SCP AE. Error message is output to the Service Log.
Failed	Identifier does not match SOP Class	A900	The C-MOVE identifier contains invalid Elements or values, or is missing mandatory Elements or values for the specified SOP Class or retrieval level. Error message is output to the Service Log.
Cancel	Matching terminated due to Cancel Request	FE00	The C-MOVE SCU sent a Cancel Request. This has been acknowledged and the export of Composite SOP Instances to the C-MOVE Destination AE has been halted.
Pending	Sub-operations are continuing	FF00	A Response with this Status Code is sent every time a Composite SOP Instance has been successfully sent to the C-MOVE Destination AE.

Table 2-43: Query-Retrieve-SCP: Communication Failure Behavior

Exception	Behavior
Timeout for an expected DICOM Message Request (DIMSE level timeout). I.e. The QUERY-RETRIEVE-SCP AE is waiting for the next C-FIND or C-MOVE Request on an open Association but the timer expires.	The Association is aborted by issuing a DICOM A-ABORT. Error message is output to the Service Log. If the Storage-SCU AE is still exporting Composite SOP Instances as a result of an earlier C-MOVE Request received on this Association, it will continue attempting to complete the entire C-MOVE Request.
Timeout for an expected DICOM PDU or TCP/IP packet (Low-level timeout). I.e. The QUERY-RETRIEVE-SCP AE is waiting for the next message PDU but the timer expires.	The Association is aborted by issuing a DICOM A-ABORT. Error message is output to the Service Log. If the Storage-SCU AE is still exporting Composite SOP Instances as a result of an earlier C-MOVE Request received on this Association, it will continue attempting to complete the entire C-MOVE Request.
Association aborted by the SCU or the network layers indicate communication loss (i.e. low-level TCP/IP socket closure)	Error message is output to the Service Log. If the Storage-SCU AE is still exporting Composite SOP Instances as a result of an earlier C-MOVE Request received on this Association, it will continue attempting to complete the entire C-MOVE Request.

2.2.6 Query/Retrieve-SCU AE Specification

2.2.6.1 SOP Classes

The Query/Retrieve-SCU Application Entity provides Standard Conformance to the following SOP Class:

Table 2-44: Query/Retrieve-SCU: Supported SOP Classes

SOP Class Name	SOP Class UID	SCU	SCP
Study Root Query/Retrieve Information Model - FIND	1.2.840.10008.1.2	Yes	No
Study Root Query/Retrieve Information Model - MOVE	1.2.840.10008.5.1.4.1.2.2.2	Yes	No

Query/Retrieve-SCU supports queries against the Query/Retrieve Information Model described in PS3.4-2009, Section C.6.2.1 using the C-FIND SCU behavior described in Section C.4.1.2.

2.2.6.2 Association Establishment Policies

2.2.6.2.1 General

The maximum PDU size offered is 32768 bytes. SOP Class Extended Negotiation is not supported. The DICOM standard Application context shall be specified.

Table 2-45: Query/Retrieve-SCU: DICOM Application Context

Application Context Name	1.2.840.10008.3.1.1.1
--------------------------	-----------------------

2.2.6.2.2 Number of Associations

Table 2-46: Query/Retrieve-SCU: Number of Associations Accepted

Maximum number of simultaneous Associations	1
---	---

2.2.6.2.3 Asynchronous Nature

Query/Retrieve-SCU does not support asynchronous communication (multiple transactions over a single Association).

Table 2-47: Query/Retrieve-SCU: Asynchronous Nature

Maximum number of outstanding asynchronous transactions	1
---	---

2.2.6.2.4 Implementation Identifying Information

The implementation information for Query/Retrieve-SCU is:

Table 2-48: Query/Retrieve-SCU: DICOM Implementation Class and Version

Implementation Class UID	1.2.840.113754.2.1.3.0
Implementation Version Name	VA DICOM V3.0

2.2.6.3 Association Initiation Policy

2.2.6.3.1 Activity—User-Initiated FIND Request

For FIND operations, Query/Retrieve-SCU initiates an association upon user request.

2.2.6.3.1.1 Description and Sequencing of Events

In manual operation, the user selects the menu option that executes the query, the user is prompted to enter the necessary information. When data entry is complete, the query is executed and the results are used to perform a C-MOVE operation.

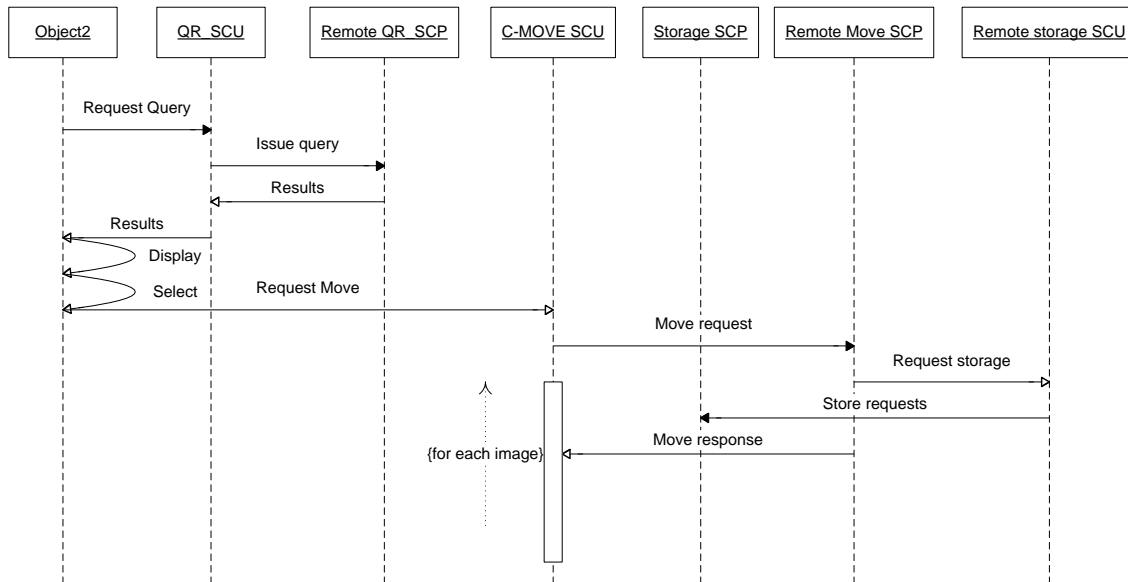

Figure 2-11: Query-Retrieve-SCU: User-initiated FIND Sequencing of Activity

2.2.6.3.1.2 Proposed Presentation Contexts

Table 2-49: Query/Retrieve-SCU: Proposed Presentation Contexts for FIND Request

Presentation Context Table					
Abstract Syntax		Transfer Syntax		Role	Extended Negotiation
Name	UID	Name List	UID List		
Study Root Query/Retrieve Information Model - FIND	1.2.840.10008.5.1.4.1.2.2.1	Implicit VR Little Endian	1.2.840.10008.1.2	SCU	None

2.2.6.3.1.2.1 SOP Specific Conformance: Study Root Query/Retrieve Information Model - FIND SOP Class

The SOP Class conforms to the basic requirements set forth by the standard. All return keys are included in the C-FIND request; the user to perform the query can enter a limited set of match keys. The allowed match keys are:

Table 2-50: Query/Retrieve-SCU: Study Root Information Model Match Keys Allowed for User Entry

Description	Tag	Type
Study Date	(0008,0020)	R
Accession Number	(0008,0050)	R
Patient's Name	(0010,0010)	R
Patient ID	(0010,0020)	R
(all keys use Range Matching as a matching Type)		

Optional keys are not supported.

Only Study Root/Study Level queries are generated. Hierarchical and Relational searches are not supported.

Negotiation of combined date-time matching and fuzzy semantic matching of person names is not supported.

Query/Retrieve-SCU uses the default character set of ISO-IR 6 in the Specific Character Set tag (0008,0005) when encoding queries and generating responses.

Query/Retrieve-SCU will behave as described below response to the status returned in the C-FIND response command message(s).

Table 2-51: Query/Retrieve-SCU: C-FIND Response Status

Service Status	Further Meaning	Status Codes	Behavior
Refused	Out of Resources	A7xx	Ignored.
Error	Identifier does not match SOP Class	A9xx	Ignored.
	Unable to process	Cxxx	Ignored.
Cancel	Matching terminated due to cancel request	FE00	Ignored.
Success	Matching is complete—no final identifier is supplied	0000	
Pending	Matches are continuing	FF00	Ignored.
	Matches are continuing—warning that one or more optional keys are not supported	FF01	Ignored.

2.2.6.3.2 Activity—Examination Complete Message Detected

When an Examination Complete message is received, Query/Retrieve-SCU immediately initiates an association with the remote C-MOVE SCP.

2.2.6.3.2.1 Description and Sequencing of Events

When an Examination Complete notification is received, it is read from an internal messaging structure and acted upon immediately. (See 2.2.8.2.1.2.6 for details on the Examination Complete message). Query/Retrieve-SCU issues a C-MOVE request to have images transmitted to VistA Imaging.

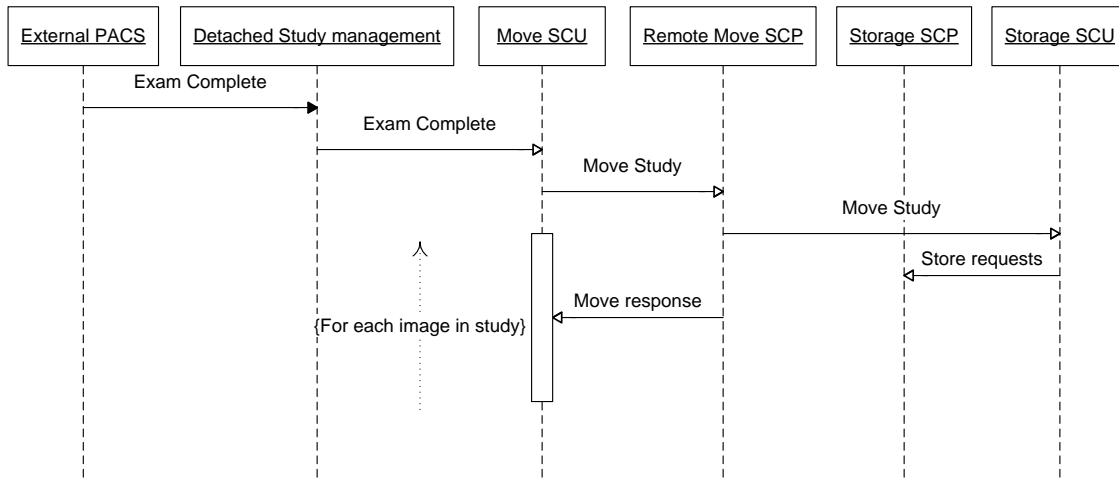

Figure 2-12: Query-Retrieve-SCU: Examination Complete Sequencing of Activity

2.2.6.3.2.2 Presentation Contexts

The following table lists the Presentation Contexts proposed by Query/Retrieve-SCU upon the receipt of the Examination Complete Event:

Table 2-52: Query/Retrieve-SCU: Proposed Presentation Contexts

Presentation Context Table					
Abstract Syntax		Transfer Syntax		Role	Extended Negotiation
Name	UID	Name List	UID List		
Study Root Query/Retrieve Information Model - MOVE	1.2.840.10008.5.1.4.1.2.2.2	Implicit VR Little Endian	1.2.840.10008.1.2	SCU	None
		Explicit VR Little Endian	1.2.840.10008.1.2.1		

2.2.6.3.2.2.1 SOP Specific Conformance: Study Root Query/Retrieve Information Model–MOVE

Query/Retrieve-SCU conforms to the SOP Class as required by the standard (PS3.4-2009Annex C.6.2.2.1.2).

Query/Retrieve-SCU supplies the AE title of the Storage-SCP as the move destination for the request.

Query/Retrieve-SCU processes the remote SCP’s responses as required (by PS3.4-2009Annex C.4.2.2.1). Sub-operations status messages are supported.

Table 2-53: Query/Retrieve-SCU: Study Level Keys for the Study Root Query/retrieve Information Model

Description	Tag	Type
Accession Number	(0008,0050)	R
Patient's Name	(0010,0010)	R
Study Instance UID	(0020,000D)	R
Patient ID	(0010,0020)	R

Query/Retrieve-SCU only performs Study Level Move.

Query/Retrieve-SCU does not issue a Cancel message on the move operation.

Table 2-54: Query/Retrieve-SCU: C-MOVE Response Status

Service Status	Further Meaning	Status Codes	Related Fields	Behavior
Refused	Out of Resources-cannot calculate number of matches	A701	(0000,0902)	Retrieval behavior terminated.
	Out of resources-unable to perform sub-operations	A702	(0000,1020) (0000,1021) (0000,1022) (0000,1023)	Retrieval behavior terminated.
	Move destination unknown	A801	(0000,0902)	Retrieval behavior terminated.
Failed	Identifier does not match SOP Class	A9xx	(0000,0901) (0000,0902)	Retrieval behavior terminated.
	Unable to process	Cxxx	(0000,0901) (0000,0902)	Retrieval behavior terminated.
Cancel	Sub-operations terminated due to Cancel Indication	FE00	(0000,1020) (0000,1021) (0000,1022) (0000,1023)	Retrieval is terminated (should never occur, since cancels never issued)
Warning	Sub-operations complete - One or more failures	B000	(0000,1020) (0000,1022) (0000,1023)	Retrieval behavior terminated.
Success	Matching is complete—no final identifier is supplied	0000	(0000,1020) (0000,1021) (0000,1022) (0000,1023)	
Pending	Sub-operations are continuing	FF00	(0000,1020) (0000,1021) (0000,1022) (0000,1023)	

2.2.6.4 Association Acceptance Policy

Query/Retrieve-SCU does not accept associations.

2.2.7 Verification AE Specification

2.2.7.1 SOP Classes

The Verification AE provides Standard Conformance to the following SOP Classes:

Table 2-55: Verification AE: Supported SOP Classes

SOP Class Name	SOP Class UID	SCU	SCP
Verification	1.2.840.10008.1.1	Yes	Yes

2.2.7.2 Association Policies

2.2.7.2.1 General

The Verification AE accepts and initiates connections. The maximum PDU size offered is 32768 bytes. SOP Class Extended Negotiation is not supported. The DICOM standard Application context shall be specified.

Table 2-56: Verification AE: DICOM Application Context

Application Context Name	1.2.840.10008.3.1.1.1
--------------------------	-----------------------

2.2.7.2.2 Number of Associations

Table 2-57: Verification AE: Number of Associations Accepted

Maximum number of simultaneous Associations	1
---	---

2.2.7.2.3 Asynchronous Nature

The Verification AE does not support asynchronous communication (multiple transactions over a single Association).

Table 2-58: Verification AE: Asynchronous Nature

Maximum number of outstanding asynchronous transactions	1
---	---

2.2.7.2.4 Implementation Identifying Information

The implementation information for the Verification AE is:

Table 2-59: Verification AE: DICOM Implementation Class and Version

Implementation Class UID	1.2.840.113754.2.1.3.0
Implementation Version Name	VA DICOM V3.0

2.2.7.3 Association Initiation Policy

The association is initiated as a result of a request to verify the presence of a remote AE.

2.2.7.3.1 Activity – Send C-ECHO Request

2.2.7.3.1.1 Description and Sequencing of Activities

The Verification AE initiates an association upon request. The association is terminated when a response is received.

2.2.7.3.1.2 Proposed Presentation Contexts

Table 2-60: Verification AE: Proposed Presentation Contexts

Presentation Context Table					
Abstract Syntax		Transfer Syntax		Role	Extended Negotiation
Name	UID	Name List	UID List		
Verification SOP Class	1.2.840.10008.1.1	Implicit VR Little Endian Explicit VR Little Endian Explicit VR Big Endian	1.2.840.10008.1.2 1.2.840.10008.1.2.1 1.2.840.10008.1.2.2	SCU	None

2.2.7.3.1.3 SOP Specific Conformance: Verification SOP Class

The Verification AE provides standard conformance to the Verification SOP Class as an SCU. The status code responses for C-ECHO are as follows:

Table 2-61: Verification AE: C-ECHO Response Status

Code	Status	Meaning
0000	Success	The C-ECHO request is accepted
C000	Error	Cannot understand

2.2.7.4 Association Acceptance Policy

The Verification AE will accept any Associations with valid application and presentation contexts.

2.2.7.4.1 Activity – Receive C-ECHO Request

2.2.7.4.1.1 Description and Sequencing of Activities

After accepting an Association, the Verification AE receives a C-ECHO request. The Verification AE then returns a C-ECHO response.

2.2.7.4.1.2 Accepted Presentation Contexts

Table 2-62: Verification AE: Accepted Presentation Contexts

Presentation Context Table					
Abstract Syntax		Transfer Syntax		Role	Extended Negotiation
Name	UID	Name List	UID List		
Verification SOP Class	1.2.840.10008.1.1	Implicit VR Little Endian Explicit VR Little Endian Explicit VR Big Endian	1.2.840.10008.1.2 1.2.840.10008.1.2.1 1.2.840.10008.1.2.2	SCP	None

2.2.7.4.1.3 SOP Specific Conformance: Verification SOP Class

The Verification AE provides standard conformance to the Verification SOP Class as an SCP. If the C-ECHO request was successfully received, a 0000 (Success) status code will be returned in the C-ECHO response. Otherwise, a C000 (Error – Cannot Understand) status code will be returned.

2.2.8 Vista Imaging PACS Text Interface AE Specification (Retired)

This specification is included to document historical behavior only. It does not adhere to current conformance statement conventions and is scheduled for future deprecation.

The VistA Imaging text interface provides all the VA Detached management SCPs. These SCPs are used to communicate asynchronous information to and from a PACS connected to VistA Imaging. The AEs provide conformance to the following SOP classes as an SCP:

Table 2-63: PACS Text Interface: Supported SOP Classes

SOP Class Name	SOP Class UID	SCU	SCP
Verification	1.2.840.10008.1.1	No	Yes
VA Detached Patient Management (Retired)	1.2.840.113754.3.1.2.1.1	No	Yes

SOP Class Name	SOP Class UID	SCU	SCP
VA Detached Patient Management Meta SOP Class (Retired)	1.2.840.113754.3.1.2.1.4	No	Yes
VA Detached Visit Management SCP (Retired)	1.2.840.113754.3.1.2.2.1	No	Yes
VA Detached Study Management SCP (Retired)	1.2.840.113754.3.1.2.3.1	No	Yes
VA Detached Study Component Management (Retired)	1.2.840.113754.3.1.2.3.2	No	Yes
VA Detached Results Management SOP Class (Retired)	1.2.840.113754.3.1.2.5.1	No	Yes
VA Detached Results Management Meta SOP Class (Retired)	1.2.840.113754.3.1.2.5.4	No	Yes
VA Detached Study Management Meta SOP Class (Retired)	1.2.840.113754.3.1.2.5.5	No	Yes
VA Detached Interpretation Management SCP (Retired)	1.2.840.113754.3.1.2.6.1	No	Yes

The Detached management SOP classes are VA-specific specializations of the Standard detached management SOP classes.

2.2.8.1 Association Establishment Policies

The AE does not establish an association.

2.2.8.2 Association Acceptance Policy

The AE will accept association any time after the interface has been initialized. Associations may be open indefinitely. The AE does not support reverse role negotiated associations. Association must remain open for the entire transaction; if the association is closed before a transaction is complete the outcome is indeterminate.

2.2.8.2.1 Real-World Activity Interface initialization

Upon the initialization of the peer the SCU connects to the SCP issuing a set of required Presentation Contexts.

2.2.8.2.1.1 Associated Real-World Activity

The SCU startup process includes the establishment of the connection to the SCP.

2.2.8.2.1.2 Presentation Context Table

Table 2-64: PACS Text Interface: Acceptable Presentation Contexts

Presentation Context Table					
Abstract Syntax		Transfer Syntax		Role	Extended Negotiation
Name	UID	Name List	UID List		
Verification	1.2.840.10008.1.1	Implicit VR Little Endian	1.2.840.10008.1.2	SCP	None
VA Detached Patient Management	1.2.840.113754.3.1.2.1.1	Implicit VR Little Endian	1.2.840.10008.1.2	SCP	None
VA Detached Patient Management Meta SOP Class (Retired)	1.2.840.113754.3.1.2.1.4	Implicit VR Little Endian	1.2.840.10008.1.2		
VA Detached Visit Management	1.2.840.113754.3.1.2.2.1	Implicit VR Little Endian	1.2.840.10008.1.2	SCP	None
VA Detached Study Management	1.2.840.113754.3.1.2.3.1	Implicit VR Little Endian	1.2.840.10008.1.2	SCP	None
VA Detached Study Component Management	1.2.840.113754.3.1.2.3.2	Implicit VR Little Endian	1.2.840.10008.1.2	SCP	None
VA Detached Results Management SOP Class (Retired)	1.2.840.113754.3.1.2.5.1	Implicit VR Little Endian	1.2.840.10008.1.2	SCP	None
VA Detached Results Management Meta SOP Class (Retired)	1.2.840.113754.3.1.2.5.4	Implicit VR Little Endian	1.2.840.10008.1.2	SCP	None
VA Detached Study Management Meta SOP Class (Retired)	1.2.840.113754.3.1.2.5.5	Implicit VR Little Endian	1.2.840.10008.1.2	SCP	None
VA Detached Interpretation Management	1.2.840.113754.3.1.2.6.1	Implicit VR Little Endian	1.2.840.10008.1.2	SCP	None

2.2.8.2.1.2.1 SOP Specific Conformance: Verification SOP Class

The Verification SOP class is fully conformant for details see PS3.4 Annex A.

2.2.8.2.1.2.2 SOP Specific Conformance: VA Detached Patient Management SOP Class

This SOP class is an extension of the standard Detached Patient Management SOP class. It provides Asynchronous notification facilities to convey HL7 ADT-related information.

DIMSE Service Group

The following table shows DIMSE-N Services applicable to the Patient IOD under the VA Detached Patient Management SOP Class.

Table 2-65: PACS Text Interface: DIMSE-N Service Group for Patient IOD

DIMSE Service Element	Usage SCU/SCP
N-EVENT-REPORT	M/M

The DIMSE-N Services and Protocol are specified in PS3.7.

Notifications

The only Supported Notification is the Patient Update. SCUs conformant to this SOP class shall treat patient updates seen the first time as a Create notification. No Delete patient notifications are generated by the interface.

Table 2-66: PACS Text Interface: Patient Notification Event Information

Event Type Name	Event Type ID	Attribute	Tag	Req. Type SCU/SCP
Patient Created	1	(Not Supported)		
Patient Deleted	2	(Not Supported)		
Patient Updated	3	Instance Creation Date	(0008,0012)	-/2
		Instance Creation Time	(0008,0013)	-/2
		Instance Creator UID	(0008,0014)	-/2
		Patient Name	(0010,0010)	-/2
		Patient ID (VA uses the social security number)	(0010,0020)	-/2
		Issuer of Patient ID	(0010,0021)	-/2
		Patient Birth Date (birth dates may be imprecise)	(0010,0030)	-/2
		Patient Sex	(0010,0040)	-/2
		Other Patient IDs (quick PID, "K6789", not unique)	(0010,1000)	-/2
		Patient's Address ⁸	(0010,1040)	-/2
		Medical Alerts	(0010,2000)	-/3
		Patient's Telephone Number(s)	(0010,2154)	-/3

⁸ Patient Address: The DICOM VR LO (VM 1) permits only a 64 character string. The address will be truncated to 64 characters if longer.

Event Type Name	Event Type ID	Attribute	Tag	Req. Type SCU/SCP
		Ethnic Group (race of patient)	(0010,2160)	-/2
		Additional Patient History	(0010,21B0)	-/2
		Patient's Institution Residence Sequence (specialization)	(0039,xx20)	-/2
		Message Handle	(FFFD,xx10)	1/1

Status Codes

There are no specific status codes. See PS3.7 for response status codes.

2.2.8.2.1.2.3 SOP Specific Conformance: VA Detached Visit Management SOP Class

The SOP class is an extension of the standard Detached Visit Management SOP class. It provides Asynchronous notification facilities to convey HL7 clinic appointment ADT related information.

2.2.8.2.1.2.3.1 DIMSE Service Group

The following table shows DIMSE-N Services applicable to the Visit IOD under the VA Detached Visit Management SOP Class.

The DIMSE-N Services and Protocol are specified in PS3.7.

Table 2-67: PACS Text Interface: DIMSE-N Service Group for Visit IOD

DIMSE Service Element	Usage SCU/SCP
N-EVENT-REPORT	M/M

2.2.8.2.1.2.3.2 Notifications

The only Supported Notifications are: Visit ADT event Admitted, Visit ADT event Transferred, and Visit ADT event Discharged.

SCUs conformant to this SOP class shall treat patient updates seen the first time as a Create notification. No Delete patient notifications are generated by the interface.

Table 2-68: PACS Text Interface: Visit ADT Notification Event Information

Event Type Name	Event Type ID	Attribute	Tag	Req. Type SCU/SCP
Admitted	3	Instance Creation Date	(0008,0012)	-/2
Transferred	4	Instance Creation Time	(0008,0013)	-/2
Discharged	5	Instance Creator UID	(0008,0014)	-/2

NETWORKING

Event Type Name	Event Type ID	Attribute	Tag	Req. Type SCU/SCP
		Admitting Diagnosis Description	(0008,1080)	-/3
		Referenced Patient Sequence	(0008,1120)	-/1
		>Referenced SOP Class UID	(0008,1150)	-/1
		>Referenced SOP Instance UID	(0008,1155)	-/1
		Referring Physician Sequence (specialization)	(0009,xx10)	-/2
		Performing Physician Sequence (specialization)	(0009,xx20)	-/2
		Patient Name	(0010,0010)	-/2
		Patient ID (VA uses the social security number)	(0010,0020)	-/2
		Issuer of Patient ID	(0010,0021)	-/2
		Patient Birth Date (birth dates may be imprecise)	(0010,0030)	-/2
		Patient Sex	(0010,0040)	-/2
		Other Patient IDs (quick PID, "K6789", not unique)	(0010,1000)	-/2
		Patient's Address	(0010,1040)	-/2
		Medical Alerts	(0010,2000)	-/3
		Patient's Telephone Number(s)	(0010,2154)	-/3
		Ethnic Group (race of patient)	(0010,2160)	-/2
		Additional Patient History	(0010,21B0)	-/2
		Visit Status ID (ADMITTED, TRANSFERED, or DISCHARGED)	(0038,0008)	-/1
		Admitting Date	(0038,0020)	-/2
		Admitting Time	(0038,0021)	-/2
		Discharge Date	(0038,0030)	-/2
		Discharge Time	(0038,0032)	-/2
		Discharge Diagnosis Code Sequence	(0038,0044)	-/2
		>Code Value	(0008,0100)	-/2
		>Code Scheme Designator	(0008,0102)	-/2
		>Code Meaning	(0008,0104)	-/2
		Current Patient Location Sequence (specialization)	(0039,xx10)	-/2
		Patient's Institution Residence Sequence (specialization)	(0039,xx20)	-/2
		Message Handle	(FFFD,xx10)	1/1

2.2.8.2.1.2.3.3 Status Codes

There are no specific status codes. See PS3.7 for response status codes.

2.2.8.2.1.2.4 SOP Specific Conformance: VA Detached Study Management SOP Class

The SOP class is an extension of the standard Detached Study Management SOP class. It provides Asynchronous notification facilities to convey Radiology registration related information.

2.2.8.2.1.2.4.1 DIMSE Service Group

The following table shows DIMSE-N Services applicable to the Study IOD under the VA Detached Study Management SOP Class.

The DIMSE-N Services and Protocol are specified in PS3.7.

Table 2-69: PACS Text Interface: DIMSE-N Service Group for Study IOD

DIMSE Service Element	Usage SCU/SCP
N-EVENT-REPORT	M/M

2.2.8.2.1.2.4.2 Notifications

The supported notifications are: Study Created, Study Updated, and Study Verified.

The delete study notification is conveyed using the study Status ID field (0032,000A). The value "CANCELED" (VA Specialization) indicates deletion.

2.2.8.2.1.2.4.2.1 Identifications

VA Radiology Package Study Identifiers

The VistA RIS assigns a "case number" to each study. This identifier has a short format consisting of a short series of digits (i.e., "nnnnn") and a long format consisting of the starting date concatenated with the short series of digits (i.e., "mmddy-nnnn"), and a site-specific format consisting of the three-digit VA Station Number prefix attached to the long format (i.e., "sss-mmddy-nnnn").

The long format of the case number ("mmddy-nnnn") or the site-specific format of the case number ("sss-mmddy-nnnn") is passed in the Accession Number (0008,0050) element. This is a permanent identifier that can be used to access the study retrospectively. (The format used for the Accession Number is a site-configurable option.)

The short format of the case number ("nnnnn") is passed in the Study ID (0020,0010) element. This is a temporary identifier that is used to conveniently access the case while it is being processed in the department. This identifier is reassigned to another case after the study is completed.

A third identifier, the DICOM Study Instance UID, is a unique permanent identifier for the study.

There are uses for all three study identifiers.

The short format of the case number, the Study ID, is convenient for manual entry at a modality to identify the study. The long format of the case number, the Accession Number, is useful for identifying the study historically. The Study Instance UID is needed to identify images produced by the modalities.

The correct Accession Number and the Study Instance UID need to be present in every image produced by the modalities in order to properly link them to the ordered study on VistA.

Institution Code Sequence (0008,0082)

The Institution Code Sequence contains the identification of the site performing the study. When a single VistA system serves multiple VA medical centers, this information may be used to segregate the orders by the performing site for the Modality Worklist function. The code (0008,0100) is the site's numeric value, while the meaning (0008,0104) is the name of the site (e.g., 688 and Washington, DC).

Imaging Type Sequence (0033,xx40, VA DHCP)

The VA's RIS subdivides the radiology service into separate specialties, each providing a different imaging type. The Imaging Types are site configurable, and vary considerably between facilities. Typically there are several supported imaging types, each of which may map to one or more modalities, as shown below.

Table 2-70: PACS Text Interface: Typical Imaging Types

Imaging Type	Modalities
General Radiology	CR, DR
Nuclear Medicine	NM
Ultrasound	US
Magnetic Resonance Imaging	MR
CT Scan	CT
Angio/Neuro/Interventional	XA, RF
Cardiology Studies (Nuc Med)	NM (maybe different than NM above)
Vascular Lab	XA, US, MA

The Imaging Type is a code sequence. The code value (0008,0100) is an abbreviation, coding scheme designator (0008,0102) is "99RAD", while the code meaning (0008,0104) is the name of the imaging type. Please note that additional imaging types will be

identified for non-radiology specialties (e.g., gastrointestinal endoscopy, pathology, dental, etc.) in the future.

It is the responsibility of the commercial Modality Worklist vendor to properly map a given site's imaging types to the corresponding modality equipment.

Requested Procedure Code (0032,1064)

The CPT code has been added to the Requested Procedure Code sequence. Two items are now present in the sequence. The first is VistA RIS encoded procedure and meaning. The second is the CPT representation of the same procedure. By providing a sequence of both codes, the interface better conveys the type of procedure requested.

Reason for Study (0033,xx50, VA DHCP)

In normal practice, a short case history accompanies the reason why the physician ordered the study. This free-text data exceeds the 64-character Long String VR provided by the standard "Reason for Study" data element (0032,1030). For this reason, a new private data element was created with a 1024-character Short Text VR.

Real-World Activity -- Examination Change

Changes to radiology examinations are sent to the PACS using the messages in Table 2-69. The format of the examination change transaction is the same as the order entry transaction. The "Study Updated Event Type" (Event Type ID = 9) is used, however. If the study has been canceled on the HIS/RIS, the Study Status ID (0032,000A) will be set to "CANCELED". Note: The value of Study Status ID = "CANCELED" is a specialization.

Real-World Activity -- Examination Verification

If the image acquisition for the examination is verified on the RIS, notification of the verification is sent to the PACS using the messages in Table 2-69. The format of the examination change transaction is the same as the order entry transaction. The "Study Updated Event Type" (Event Type ID = 6) is used, however. The value of the Study Status ID (0032,000A) will be set to "VERIFIED". The Study Verified Date (0032,0032) and Study Verified Time (0032,0033) will be set.

Table 2-71: PACS Text Interface: Study Notification Event Information

Event Type Name	Event Type ID	Attribute	Tag	Req. Type SCU/SCP
Created	1	Instance Creation Date	(0008,0012)	-/2
Updated	9	Instance Creation Time	(0008,0013)	-/2
		Instance Creation UID	(0008,0014)	-/2
		Accession Number (radiology case number, long format)	(0008,0050)	-/1
		Institution Code Sequence	(0008,0082)	-/1
		>Code Value	(0008,0100)	-/2
		>Coding Scheme Designator	(0008,0102)	-/2

NETWORKING

Event Type Name	Event Type ID	Attribute	Tag	Req. Type SCU/SCP
		>Code Meaning	(0008,0104)	-/2
		Referenced Patient Sequence	(0008,1120)	-/1
		>Referenced SOP Class UID	(0008,1150)	-/1
		>Referenced SOP Instance UID	(0008,1155)	-/1
		Referenced Visit Sequence	(0008,1125)	-/1
		>Referenced SOP Class UID	(0008,1150)	-/1
		>Referenced SOP Instance UID	(0008,1155)	-/1
		Patient Name	(0010,0010)	-/2
		Patient ID (VA uses the social security number)	(0010,0020)	-/2
		Issuer of Patient ID	(0010,0021)	-/2
		Patient Birth Date (birth dates may be imprecise)	(0010,0030)	-/2
		Patient Sex	(0010,0040)	-/2
		Other Patient IDs (quick PID, "K6789", not unique)	(0010,1000)	-/2
		Patient's Address	(0010,1040)	-/2
		Medical Alerts	(0010,2000)	-/3
		Patient's Telephone Number(s)	(0010,2154)	-/3
		Ethnic Group (race of patient)	(0010,2160)	-/2
		Additional Patient History	(0010,21B0)	-/2
		Study ID (radiology case number, short format)	(0020,0010)	-/2
		Study Status ID	(0032,000A)	-/2
		Study Priority ID (LOW, MED, HIGH)	(0032,000C)	-/2
		Scheduled Study Start Date	(0032,1000)	-/2
		Scheduled Study Start Time	(0032,1001)	-/2
		Requested Procedure Description	(0032,1060)	-/2
		Requested Procedure Code Sequence (local & CPT codes)	(0032,1064)	-/2
		>Code Value	(0008,0100)	-/2
		>Coding Scheme Designator	(0008,0102)	-/2
		>Code Meaning	(0008,0104)	-/2
		Study Comments	(0032,4000)	-/2
		Requesting Physician Sequence (specialization)	(0033,xx10)	-/2

Event Type Name	Event Type ID	Attribute	Tag	Req. Type SCU/SCP
		Scheduled Study Location Sequence(specialization)	(0033,xx20)	-/2
		Requesting Service Sequence (specialization)	(0033,xx30)	-/2
		Imaging Type Sequence (specialization)	(0033,xx40)	-/2
		Reason for Study	(0033,xx50)	-/2
		Message Handle	(FFFD,xx10)	1/1
		Instance Creation Date	(0008,0012)	-/2
		Instance Creation Time	(0008,0013)	-/2
		Instance Creation UID	(0008,0014)	-/2
		Accession Number (radiology case number, long format)	(0008,0050)	-/1
		Institution Code Sequence	(0008,0082)	-/1
		>Code Value	(0008,0100)	-/2
Verified	6	>Coding Scheme Designator	(0008,0102)	-/2
		>Code Meaning	(0008,0104)	-/2
		Referenced Patient Sequence	(0008,1120)	-/1
		>Referenced SOP Class UID	(0008,1150)	-/1
		>Referenced SOP Instance UID	(0008,1155)	-/1
		Referenced Visit Sequence	(0008,1125)	-/1
		>Referenced SOP Class UID	(0008,1150)	-/1
		>Referenced SOP Instance UID	(0008,1155)	-/1
		Patient Name	(0010,0010)	-/2
		Patient ID (VA uses the social security number)	(0010,0020)	-/2
		Issuer of Patient ID	(0010,0021)	-/2
		Patient Birth Date (birth dates may be imprecise)	(0010,0030)	-/2
		Patient Sex	(0010,0040)	-/2
		Other Patient IDs (quick PID, "K6789", not unique)	(0010,1000)	-/2
		Patient's Address	(0010,1040)	-/2
		Medical Alerts	(0010,2000)	-/3
		Patient's Telephone Number(s)	(0010,2154)	-/3
		Ethnic Group (race of patient)	(0010,2160)	-/2
		Additional Patient History	(0010,21B0)	-/2

Event Type Name	Event Type ID	Attribute	Tag	Req. Type SCU/SCP
		Study ID (radiology case number, short format)	(0020,0010)	-/2
		Study Status ID (=VERIFIED)	(0032,000A)	-/2
		Study Priority ID (LOW, MED, HIGH)	(0032,000C)	-/2
		Study Verified Time	(0032,0033)	-/2
		Study Verified Date	(0032,0032)	-/2
		Requested Procedure Description	(0032,1060)	-/2
		Requested Procedure Code Sequence (local & CPT codes)	(0032,1064)	-/2
		>Code Value	(0008,0100)	-/2
		>Coding Scheme Designator	(0008,0102)	-/2
		>Code Meaning	(0008,0104)	-/2
		Study Comments	(0032,4000)	-/2
		Requesting Physician Sequence (specialization)	(0033,xx10)	-/2
		Scheduled Study Location Sequence(specialization)	(0033,xx20)	-/2
		Requesting Service Sequence (specialization)	(0033,xx30)	-/2
		Imaging Type Sequence (specialization)	(0033,xx40)	-/2
		Reason for Study	(0033,xx50)	-/2
		Message Handle	(FFFD,xx10)	1/1

2.2.8.2.1.2.4.3 Status Codes

There are no specific status codes. See PS3.7 for response status codes.

2.2.8.2.1.2.5 SOP Specific Conformance for SOP Class VA Detached Result Management

The SOP class is an extension of the standard Detached Result Management SOP class. It provides Asynchronous notification facilities to convey Radiology registration-related information.

2.2.8.2.1.2.5.1 DIMSE Service Group

The following table shows DIMSE-N Services applicable to the Visit IOD under the VA Detached Study Management SOP Class.

The DIMSE-N Services and Protocol are specified in PS3.7.

Table 2-72: PACS Text Interface: DIMSE-N Service Group for Visit IOD

DIMSE Service Element	Usage SCU/SCP
N-EVENT-REPORT	M/M

2.2.8.2.1.2.5.2 Notifications

The only supported Notification is: Interpretation Updated

SCUs conformant to this SOP class shall treat interpretation updates seen the first time as a Create notification.

Notes

1. Specialization has added the Referenced Patient Sequence and the Referenced Study Sequence. The Detached Results Management SOP Class will not be used.
2. The Interpretation Text (4008,010B) and the Interpretation Diagnosis Description (4008,0115) are used interchangeably with the VistA RIS. Since the Interpretation Text entered on the VistA RIS frequently exceeds the 1024-byte Short Text VR provided by DICOM, and since the Interpretation Diagnosis Description is a 10240-byte Long Text VR in DICOM, both text fields will be passed in the Interpretation Diagnosis Description element.

Table 2-73: PACS Text Interface: Interpretation Update Notification Event Information

Event Type Name	Event Type ID	Attribute	Tag	Req. Type SCU/SCP
Updated	6	Instance Creation Date	(0008,0012)	-/1
		Instance Creation Time	(0008,0013)	-/2
		Instance Creator UID	(0008,0014)	-/2
		Referenced Results Sequence	(0008,1100)	-/1
		>Referenced SOP Class UID	(0008,1150)	-/1
		>Referenced SOP Instance UID	(0008,1155)	-/1
		Referenced Study Sequence (specialization)	(0008,1110)	-/1
		>Referenced SOP Class UID	(0008,1150)	-/1
		>Referenced SOP Instance UID	(0008,1155)	-/1
		Referenced Patient Sequence (specialization)	(0008,1120)	-/1
		>Referenced SOP Class UID	(0008,1150)	-/1
		>Referenced SOP Instance UID	(0008,1155)	-/1
		Patient Name	(0010,0010)	-/2

NETWORKING

Event Type Name	Event Type ID	Attribute	Tag	Req. Type SCU/SCP
		Patient ID (VA uses the social security number)	(0010,0020)	-/2
		Issuer of Patient ID	(0010,0021)	-/2
		Patient Birth Date (birth dates may be imprecise)	(0010,0030)	-/2
		Patient Sex	(0010,0040)	-/2
		Other Patient IDs (quick PID, "K6789", not unique)	(0010,1000)	-/2
		Patient's Address	(0010,1040)	-/2
		Medical Alerts	(0010,2000)	-/3
		Patient's Telephone Number(s)	(0010,2154)	-/3
		Ethnic Group (race of patient)	(0010,2160)	-/2
		Additional Patient History	(0100,21B0)	-/2
		Interpretation Transcription Date (transcribed only)	(4008,0108)	-/1
		Interpretation Transcription Time (transcribed only)	(4008,0109)	-/1
		Interpretation Text	(4008,010B)	-/1
		Interpretation Approver Sequence	(4008,0111)	-/1
		>Interpretation Approval Date(s)	(4008,0112)	-/1
		>Interpretation Approval Time(s)	(4008,0113)	-/2
		>Physician Approving Interpretation Sequence	(4009,xx20)	-/2
		Interpretation Diagnosis Description	(4008,0115)	-/2
		Interpretation Diagnosis Code Sequence	(4008,0117)	-/2
		>Code Value	(0008,0100)	-/1C
		>Coding Scheme Designator (all are local)	(0008,0102)	1/1C
		>Code Meaning	(0008,0103)	
		Interpretation Type ID (REPORT or AMENDMENT)	(4008,0210)	-/2
		Interpretation Status ID (TRANSCRIBED or APPROVED)	(4008,0212)	-/2
		Interpretation Author Sequence (specialization)	(4009,xx10)	-/1
		Message Handle	(FFFD,xx10)	1/1

2.2.8.2.1.2.5.3 Status Codes

There are no specific status codes. See PS3.7 for response status codes.

2.2.8.2.1.2.6 SOP Specific Conformance: VA Detached Study Component Management SOP Class

The SOP class is an extension of the standard Detached Study Component Management SOP class. It provides asynchronous notification allowing an SCU to create an instance of the Study Component SOP on the SCP, linking it to a patient/study and relate a series of images. The primary use of this SOP Class is the Examination Complete state information transfer from a commercial PACS to VistA Imaging.

The VA requires that the PACS AE provide the Text Gateway AE with the Study UID and the set of Image UIDs after completion of image acquisition. This information will be used to request the images from the PACS.

The DIMSE N-CREATE Service allows a SCU to create an instance of the Study Component SOP on the SCP, link it to a patient/study and relate a series of images to it.

The PACS AE shall use the N-CREATE of the Study Component Management SOP Class to inform the Text Gateway AE when the complete set of images for a study becomes available.

DIMSE Service Group

The following table shows DIMSE-N Services applicable to the Visit IOD under the VA Detached Study Management SOP Class.

The DIMSE-N Services and Protocol are specified in PS3.7.

Table 2-74: PACS Text Interface: DIMSE-N Service Group for Visit IOD

DIMSE Service Element	Usage SCU/SCP
N-EVENT-CREATE	M/M

Notifications

The only supported notification is Study Component Created.

Table 2-75: PACS Text Interface: Examination Complete N-CREATE Attributes

Attribute	Tag	Req. Type (SCU/SCP)
Study Date	(0008,0020)	1/1
Study Time	(0008,0030)	1/1
Accession Number (radiology case number, long format)	(0008,0050)	1/1
Modality	(0008,0060)	1/1
Procedure Code Sequence	(0008,1032)	1/1

NETWORKING

Attribute	Tag	Req. Type (SCU/SCP)
>Code Value	(0008,0100)	1/1
>Coding Scheme Designator (all are local)	(0008,0102)	1/1
>Code Meaning	(0008,0104)	1/1
Study Description	(0008,1030)	2/2
Referenced Study Sequence	(0008,1110)	1/1
>Referenced SOP Class UID	(0008,1150)	1/1
>Referenced SOP Instance UID	(0008,1155)	1/1
Referenced Series Sequence	(0008,1115)	2/2
>Series Date	(0008,0021)	2/2
>Series Time	(0008,0031)	2/2
>Series Instance UID	(0020,000E)	2/2
>Retrieve Application Entity Title	(0008,0054)	2/1
>Storage Media File-Set ID	(0088,0130)	2/1
>Storage Media File-Set UID	(0088,0140)	2/1
>Referenced Image Sequence	(0008,1140)	2/2
>>Referenced SOP Class UID	(0008,1120)	2/2
>>Referenced SOP Class Instance UID	(0008,1155)	2/2
>>Retrieve Application Entity Title	(0008,0054)	2/1
>>Storage Media File-Set ID	(0088,0130)	2/1
>>Storage Media File-Set UID	(0088,0140)	2/1
Referenced Patient Sequence (specialization)	(0008,1120)	1/1
>Referenced SOP Class UID	(0008,1150)	1/1
>Referenced SOP Instance UID	(0008,1155)	1/1
Patient Name	(0010,0010)	2/2
Patient ID (VA uses the social security number)	(0010,0020)	2/2
Issuer of Patient ID	(0010,0021)	2/2
Patient Birth Date (birth dates may be imprecise)	(0010,0030)	2/2
Patient Sex	(0010,0040)	2/2
Study ID	(0020,0010)	2/2
Study Component Status ID (Completed or Verified)	(0032,1055)	1/1
Message Handle	(FFFF,xx10)	1/1

2.2.8.2.1.2.6.1 Status Codes

There are no specific status codes. See PS3.7 for response status codes.

2.2.8.2.1.3 Presentation Context Acceptance Criterion

Any combinations of the offered Presentation Context will be accepted.

2.2.8.2.1.4 Transfer Syntax Selection Policies

The default Implicit VR Little Endian Transfer Syntax is the only accepted transfer syntax.

2.2.8.3 Extensions/Specializations/Privatizations

2.2.8.3.1 Detached Management SOP class extension

The VA implementation is extending the standard Detached Patient/Visit/Study/Result management SOP Classes. The following specializations and extensions shall apply to all of these SOP Classes.

2.2.8.3.1.1 Passing PID Information with each N-EVENT-REPORT transaction.

Every N-EVENT-REPORT transaction used to communicate each event includes the patient identification information.

VistA Imaging does not implement N-GET services for the detached management SOP classes. The inclusion of the patient information into every message eliminates the startup problem associated with missing referenced patient instances in the SCUs database. The SCU can create new patient records from the information contained in the N-EVENT-REPORT message. As a side benefit it also makes tracing the information easier.

2.2.8.3.1.2 Report Transfer Issues

The default technique for a DICOM service class provider to send reports to a PACS requires two steps: one to create the result object and another to create the interpretation object. The VA has one-to-one-to-one mapping between studies, reports, and interpretations, and sends one transaction rather than the two. The VA Detached Interpretation Management SOP Class Interpretation Updated process is used. The Referenced Patient Sequence and Referenced Study Sequence are added to the message as a specialization, to provide enough information to create the result object, if necessary.

2.2.8.3.1.3 Passing PID Information with the N-CREATE transaction

The Referenced Patient Sequence and patient information are added to the N-CREATE of the VA Study Component Management for the Notification of Study's Images transaction. This is needed for the processing of the message on VistA.

2.2.8.3.1.4 Passing Physicians and Institutional Locations

Physician and institutional location information are sent as coded sequences.

2.2.8.3.1.5 Passing Image Type

The type of imaging required for the study is sent as a coded sequence. Within VistA, the image type maps to one or more modalities.

2.2.8.3.1.6 Private Sequences

Unless otherwise noted, all private sequences will have only one item per sequence.

Table 2-76: PACS Text Interface: Physician Sequences

Referring Physician Sequence

Attribute	Tag	Req. Type (SCU/SCP)
Referring Physician Sequence	(0009,xx10)	
>Code Value	(0008,0100)	
>Coding Scheme Designator	(0008,0102)	
>Referring Physician's Name	(0008,0090)	
>Referring Physician's Address	(0008,0092)	
>Referring Physician's Telephone Number(s)	(0008,0094)	

Performing Physician Sequence

Attribute	Tag	Req. Type (SCU/SCP)
Performing Physician Sequence	(0009,xx20)	
>Code Value	(0008,0100)	
>Coding Scheme Designator	(0008,0102)	
>Performing Physician's Name	(0008,1050)	

Requesting Physician Sequence

Attribute	Tag	Req. Type (SCU/SCP)
Requesting Physician Sequence	(0033,xx10)	
>Code Value	(0008,0100)	
>Coding Scheme Designator	(0008,0102)	
>Requesting Physician's Name	(0032,1032)	

Interpretation Author Sequence

Attribute	Tag	Req. Type (SCU/SCP)
Interpretation Author Sequence	(4009,xx10)	
>Code Value	(0008,0100)	
>Coding Scheme Designator	(0008,0102)	
>Interpretation Author's Name	(4008,010C)	

Physician Approving Interpretation Sequence

Attribute	Tag	Req. Type (SCU/SCP)
Physician Approving Interpretation Sequence	(4009,xx20)	
>Code Value	(0008,0100)	
>Coding Scheme Designator	(0008,0102)	
>Name of Physician Approving Interpretation	(4008,0114)	

Current Patient Location Sequence

Attribute	Tag	Req. Type (SCU/SCP)
Current Patient Location Sequence	(0039,xx10)	
>Code Value	(0008,0100)	
>Coding Scheme Designator	(0008,0102)	
>Current Patient Location	(0038,0300)	

Patient's Institutional Residence Sequence

Attribute	Tag	Req. Type (SCU/SCP)
Patient's Institutional Residence Sequence	(0039,xx20)	
>Code Value	(0008,0100)	
>Coding Scheme Designator	(0008,0102)	
>Patient's Institutional Residence	(0038,0400)	

Scheduled Study Location Sequence

Attribute	Tag	Req. Type (SCU/SCP)
Scheduled Study Location Sequence	(0033,xx20)	
>Code Value	(0008,0100)	
>Coding Scheme Designator	(0008,0102)	
>Scheduled Study Location	(0032,1020)	

Requesting Service Sequence

Attribute	Tag	Req. Type (SCU/SCP)
Requesting Service Sequence	(0033,xx30)	
>Code Value	(0008,0100)	
>Coding Scheme Designator	(0008,0102)	
>Requesting Service	(0032,1033)	

Imaging Type Sequence

Attribute	Tag	Req. Type (SCU/SCP)
Imaging Type Sequence	(0033,xx40)	
>Code Value	(0008,0100)	
>Coding Scheme Designator	(0008,0102)	
>Code Meaning	(0008,0104)	

Reason for Study

Attribute	Tag	Req. Type (SCU/SCP)
Reason for Study (VR is ST, Short Text)	(0033,xx50)	

2.2.8.3.1.7 Message Priority and Message Handle.

Like the DIMSE-C C-STORE and C-MOVE services, all DIMSE-N services shall use the priority parameter. The priority may be LOW, MEDIUM, or HIGH. The priority of a DICOM message will be indicated by Command Field (0000,0700) of the Request (*-RQ) and shall be returned unmodified by the Response (*-RSP).

The Message Handle needs to be added to all the DIMSE-N messages. This is a short text (ST) element that is passed with the Request (*-RQ) and shall be returned intact by the Response (*-RSP). The data in this element is needed by the Text Gateway AE to match up the Request (*-RQ) and with the Response (*-RSP).

Table 2-77: PACS Text Interface: Message Handle

Attribute	Tag	Req. Type (SCU/SCP)
Message Handle	(FFFD,xx10)	1/1

The element contains data describing the message. (see example below)

Example:

```
(FFFD,0010)    Owner of Group    "VA DHCP"
(FFFD,1010)    Message Handle    "ORDER ENTRY"
                                     "d:\DICOM\DATA1\U000000\U00000000.DCM"
                                     "HL7(466633)"
```

2.2.8.3.1.8 Owner of Private Elements

The code VA DHCP shall be used to identify all private elements created by the VA.

2.3 Network Interfaces

2.3.1 Physical Network Interface

Platform-supplied physical network interfaces are supported. The most common interfaces are:

- Ethernet 1000baseT
- Ethernet 100baseT
- Ethernet 10baseT

2.3.2 Additional Protocols

VistA Imaging conforms to the System Management Profiles listed below. All requested transactions for the listed profiles and actors are supported. VistA Imaging does not support any optional transactions.

Table 2-78: Supported System Management Profiles

Profile Name	Actor	Protocols Used	Optional Transactions	Security Support
Network Address Management	DHCP Client	DHCP	N/A	N/A
	DNS Client	DNS	N/A	N/A

2.3.2.1 DHCP

DHCP can be used to obtain TCP/IP network configuration information. The network parameters obtainable via DHCP are shown below. If the DHCP server does not provide a value for a given parameter, the default value shown below is used.

Values for network parameters set in the Windows' Local Area Network Connection Properties dialog take precedence over values obtained from the DHCP server. Support for DHCP can be configured via the OS-supplied network configuration tools. If DHCP is not in use, TCP/IP network configuration information can be manually configured via the OS network configuration utilities.

Table 2-79: Supported DHCP Parameters

DHCP Parameter	Default Value
IP Address	None
Hostname	Requested machine name
List of NTP servers	Empty list
List of DNS servers	Empty list
Routers	Empty list
Static routes	None
Domain name	None
Subnet mask	Derived from IP Address (see service manual)
Broadcast address	Derived from IP Address (see service manual)
Default router	None
Time offset	Site configurable (from Time zone)
MTU	Network Hardware Dependent
Auto-IP permission	No permission

If the DHCP server refuses to renew a lease on the assigned IP address, all active DICOM Associations will be aborted.

2.3.2.2 DNS

DNS can be used for address resolution. If DHCP is not in use or the DHCP server does not return any DNS server addresses, the identity of a DNS server can be configured via the Windows network service/installation tool. If a DNS server is not in use, local mapping between hostname and IP address can be manually configured via the Windows' hosts file.

2.3.3 IPv4 and IPv6 Support

VistA Imaging supports both IPv4 and IPv6. It does not use any of the optional configuration identification or security features of IPv6.

2.4 Configuration

The system is configured using master files. These master files are read into the configuration database during the installation/configuration of the system. The configuration database may be updated dynamically as well.

Table 2-80: Configuration Master Files

File	Purpose
AE_TITLE.DIC	Contains aliases for the Called AE Title.
Instrument.dic	Contains Storage-SCP port definitions.
Modality.dic	Contains modality device definitions.
SCU_list.dic file	Contains definitions for remote SCPs (DICOM destinations) that the system is expected to connect to.
worklist.dic file	Contains definitions for modality worklist SCUs. This file constrains the Scheduled Procedure Steps returned to a specific SCU based on the AE Title, intended use (radiology, ophthalmology dentistry, etc.), and modality type (CT, MR, CR etc.) of the SCU's request. For more information, refer to the <i>DICOM Gateway Installation Guide</i> .

The format specifications of these master files can be located in the system installation and administrator manuals.

Starting or not starting certain AEs can alter the system configuration. Not all application entities must be started in order to achieve an operational system. Sites may decide to use the system to serve up a modality worklist and not to use its imaging features. This conformance statement only addresses conformance of individual Application Entities. It does not address interdependencies of the different applications. For the required set of applications running to satisfy different configurations, refer to the *DICOM Gateway Installation Guide*.

2.4.1 AE Title/Presentation Address Mapping

2.4.1.1 Local AE Titles

Table 2-81: AE Title Configuration

Application Entity	Default AE Title	Default TCP/IP Port
Storage-SCP	VISTA_STORAGE	60100-65535
Storage-SCU	VISTA_SEND_IMAGE	n/a
Modality-Worklist-SCP	VISTA_WORKLIST	60010
Modality-Worklist-SCU	n/a	n/a
Query-Retrieve-SCP	DICOM_QR	60500
Query-Retrieve-SCU	VISTA_QR_SCU	n/a
Verification AE	n/a	n/a
VA Detached patient/study/result management SCP	VISTA_PACS_IF	n/a

This implementation does not support the Application Configuration Management Profile as an LDAP Client actor (see PS3.15-2009).

2.4.1.2 Remote AE Titles

2.4.1.2.1 Remote SCPs

Configuration of the remote AET, port number, host names, IP addresses and capabilities for all remote SCPs is specified in the SCU_List.dic.

This implication does not support the Application Configuration Management Profile as an LDAP Client actor (see PS3.15-2009).

2.4.2 Parameters

The table below only shows those configuration parameters relevant to DICOM communication. See to the *DICOM Gateway Installation Guide* for details on general configuration.

Table 2-82: Configuration Parameters

Parameter	Configurable (Yes/No)	Default Value
General Parameters for All AEs		
Time-out waiting for acceptance or rejection Response to an Association Open Request. (Application Level timeout)	No	n/a
General DIMSE level time-out values	No	n/a
Time-out waiting for response to TCP/IP connect request. (Low-level timeout)	No	n/a
Time-out waiting for acceptance of a TCP/IP message over the network. (Low-level timeout)	No	n/a
Time-out for waiting for data between TCP/IP packets. (Low-level timeout)	No	n/a
Any changes to default TCP/IP settings, such as configurable stack parameters.	No	n/a
Other configurable parameters	n/a	n/a
AE-specific Parameters (all AEs except Query/Retrieve SCP)		
Size constraint in maximum object size (In particular when accommodating Multiframe objects (e.g. Ultrasound Multiframe, NM, XA, RF), a receiver might have a certain restriction with regard to its maximum length. This restriction should be specified here.)	No	n/a
Maximum PDU size the AE can receive	No	n/a
Maximum PDU size the AE can send	No	n/a
AE specific DIMSE level time-out values	No	n/a
Number of simultaneous Associations by Service and/or SOP Class	1	1
<SOP Class support> (e.g. Multi-frame vs. single frame vs. SC support), when configurable	Yes	all SOP Classes
<Transfer Syntax support>, e.g. JPEG, Explicit VR, when configurable	Yes	Implicit V/R Little Endian

Parameter	Configurable (Yes/No)	Default Value
Query/Retrieve SCP Parameters		
Size constraint in maximum object size (In particular when accommodating Multiframe objects (e.g. Ultrasound Multiframe, NM, XA, RF), a receiver might have a certain restriction with regard to its maximum length. This restriction should be specified here.)	No	No restriction
Maximum PDU size the AE can receive	Yes	32768
Maximum PDU size the AE can send	Yes	32768
AE specific DIMSE level time-out values	Yes	180
Number of simultaneous Associations by Service and/or SOP Class	Yes	180
<SOP Class support> (e.g. Multi-frame vs. single frame vs. SC support), when configurable	Yes	n/a
<Transfer Syntax support>, e.g. JPEG, Explicit VR, when configurable	Yes	n/a

3 MEDIA INTERCHANGE

3.1 Implementation Model

3.1.1 Application Data Flow

The figure below illustrates the data flow for VistA-Imaging-FSR.

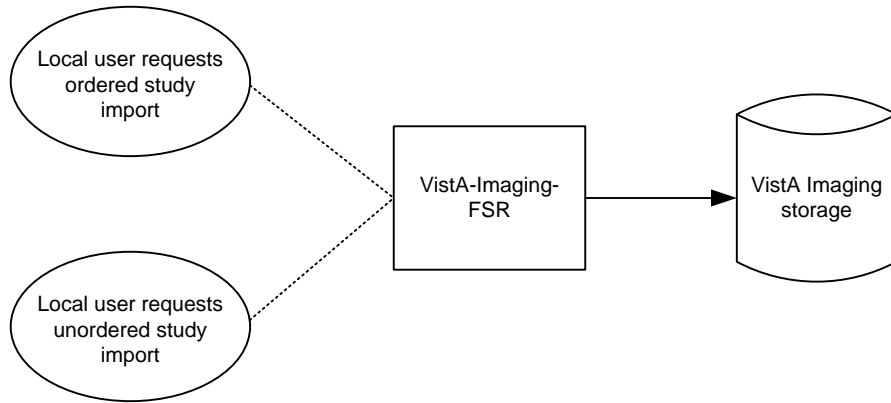

Figure 3-1: Application Data Flow Diagram for Media Storage

3.1.2 Functional Definitions of AEs

3.1.2.1 Functional Definition of VistA-Imaging-FSR

The VistA-Imaging-FSR provides a user interface that is used to select PS 3.10-compliant files from removable media, associate those files with an existing order (or create a new order if needed), then load the files into VistA Imaging. The application will communicate with other Imaging AEs as needed.

3.1.3 Sequencing of Real-World Activities

All activities relating to media are initiated in the user interface, and another activity may not be initiated until the prior activity has completed.

3.1.4 File Meta Information for Implementation Class and Version

Not applicable since VistA-Imaging-FSR is not an FSC (File-set Creator) or FSU (File-set Updater).

3.2 AE Specifications

3.2.1 VistA-Imaging-FSR Specification

VistA-Imaging-FSR provides standard conformance to the Media Storage Service Class. The Application Profiles and roles are listed below:

Table 3-1: VistA-Imaging-FSR Application Profiles, Activities, and Roles

Supported Application Profile	Real World Activity	Roles
General Purpose CD-R Interchange	Import media file	FSR
General Purpose DVD-RAM	Import media file	FSR

3.2.1.1 File Meta Information for the AE

Not applicable since VistA-Imaging-FSR is not an FSC (File-set Creator) or FSU (File-set Updater).

3.2.1.2 Real World Activities

3.2.1.2.1 Activity – Import media file

VistA-Imaging-FSR is activated by the user. VistA-Imaging-FSR presumes that supported media is already accessible.

The first thing VistA-Imaging-FSR does is to check the objects on the media. VistA-Imaging notifies the user if:

- 1) One or more of the objects have already been imported
- 2) One or more of the objects are not supported

As a part of activating VistA-Imaging-FSR, the user indicates the nature of the objects to be imported. VistA-Imaging-FSR allows for:

- Ordered studies (images will be associated with existing orders using internal reconciliation processes).
- Unordered studies (new orders will be created based on user input, then associated with imported images using internal processes).

For a given user session, study-to-order reconciliation (with or without order creation) is repeated for each user selected study, then all images are imported in a single operation.

The following diagram summarizes the Import media file real world activity.

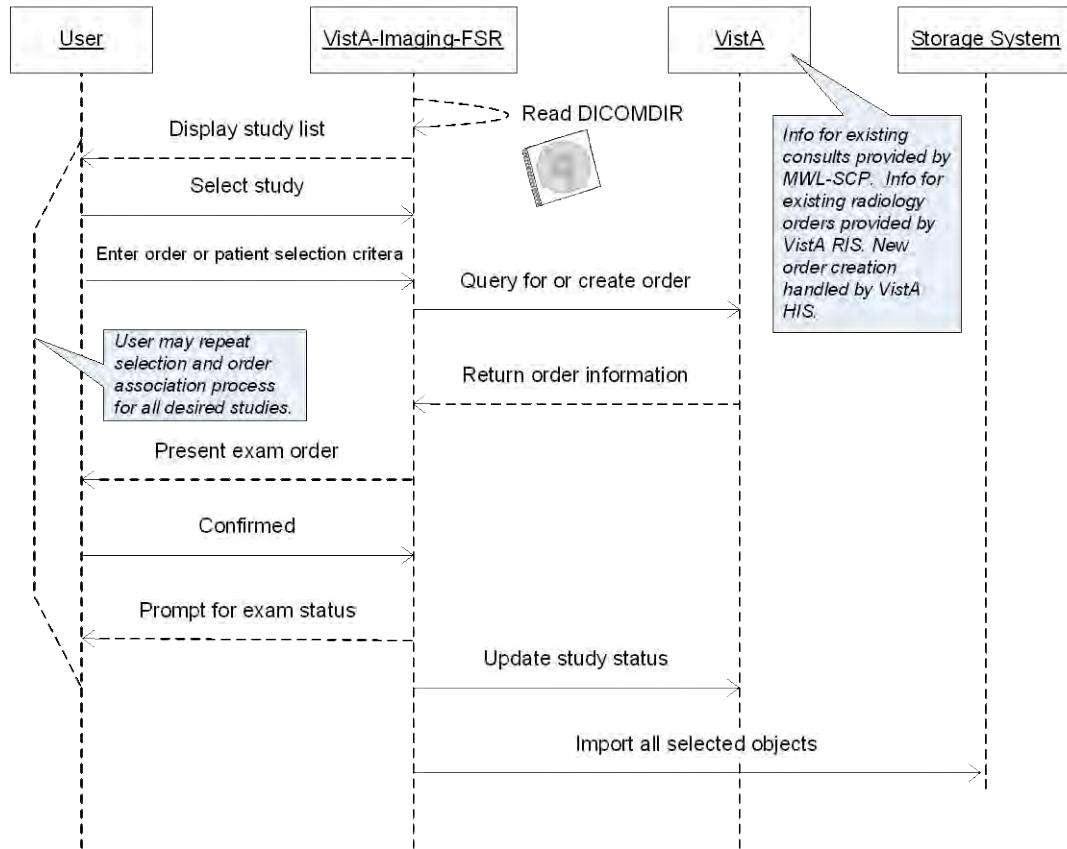

Figure 3-2: VistA-Imaging-FSR: Sequencing of Activity

3.2.1.2.1.1 Media Storage Application Profiles

VistA-Imaging-FSR supports the STD-GEN-CD and STD-GEN-DVD-RAM Application Profiles for this real world activity.

3.2.1.2.1.1.1 Options

VistA-Imaging-FSR supports the SOP Classes and Transfer Syntaxes listed in the table below:

Table 3-2: VistA Imaging FSR: IODs, SOP classes and Transfer Syntaxes

SOP Class	SOP Class UID	Transfer Syntax Name	Transfer Syntax UID
Basic Directory	1.2.840.10008.1.3.10	Explicit VR Little Endian	1.2.840.10008.1.2.1

SOP Class	SOP Class UID	Transfer Syntax Name	Transfer Syntax UID
Computed Radiography Image Storage	1.2.840.10008.5.1.4.1.1.1	Implicit VR Little Endian Explicit VR Little Endian JPEG Lossy Baseline (Process 1) JPEG Lossless Non-Hierarchical (Process 14)	1.2.840.10008.1.2 1.2.840.10008.1.2.1 1.2.840.10008.1.2.4.50 1.2.840.10008.1.2.4.57
Digital X-Ray Image Storage - For Presentation	1.2.840.10008.5.1.4.1.1.1.1	Implicit VR Little Endian Explicit VR Little Endian JPEG Lossy Baseline (Process 1) JPEG Lossless Non-Hierarchical (Process 14)	1.2.840.10008.1.2 1.2.840.10008.1.2.1 1.2.840.10008.1.2.4.50 1.2.840.10008.1.2.4.57
Digital X-Ray Image Storage - For Processing	1.2.840.10008.5.1.4.1.1.1.1.1	Implicit VR Little Endian Explicit VR Little Endian	1.2.840.10008.1.2 1.2.840.10008.1.2.1
Digital Mammography X-Ray Image Storage - For Presentation	1.2.840.10008.5.1.4.1.1.1.2	Implicit VR Little Endian Explicit VR Little Endian	1.2.840.10008.1.2 1.2.840.10008.1.2.1
Digital Mammography X-Ray Image Storage - For Processing	1.2.840.10008.5.1.4.1.1.1.2.1	Implicit VR Little Endian Explicit VR Little Endian	1.2.840.10008.1.2 1.2.840.10008.1.2.1
Digital Intra-oral X-Ray Image Storage - For Presentation	1.2.840.10008.5.1.4.1.1.1.3	Implicit VR Little Endian Explicit VR Little Endian JPEG Lossy Baseline (Process 1) JPEG Lossless Non-Hierarchical (Process 14)	1.2.840.10008.1.2 1.2.840.10008.1.2.1 1.2.840.10008.1.2.4.50 1.2.840.10008.1.2.4.57
Digital Intra-oral X-Ray Image Storage - For Processing	1.2.840.10008.5.1.4.1.1.1.3.1	Implicit VR Little Endian Explicit VR Little Endian	1.2.840.10008.1.2 1.2.840.10008.1.2.1
CT Image Storage	1.2.840.10008.5.1.4.1.1.2	Implicit VR Little Endian Explicit VR Little Endian JPEG Lossy Baseline (Process 1) JPEG Lossless Non-Hierarchical (Process 14)	1.2.840.10008.1.2 1.2.840.10008.1.2.1 1.2.840.10008.1.2.4.50 1.2.840.10008.1.2.4.57
Ultrasound Multi-frame Image Storage (Retired)	1.2.840.10008.5.1.4.1.1.3	Implicit VR Little Endian Explicit VR Little Endian JPEG Lossy Baseline (Process 1) JPEG Lossless Non-Hierarchical (Process 14)	1.2.840.10008.1.2 1.2.840.10008.1.2.1 1.2.840.10008.1.2.4.50 1.2.840.10008.1.2.4.57
Ultrasound Multi-frame Image Storage	1.2.840.10008.5.1.4.1.1.3.1	Implicit VR Little Endian Explicit VR Little Endian JPEG Lossy Baseline (Process 1) JPEG Lossless Non-Hierarchical (Process 14)	1.2.840.10008.1.2 1.2.840.10008.1.2.1 1.2.840.10008.1.2.4.50 1.2.840.10008.1.2.4.57

MEDIA INTERCHANGE

SOP Class	SOP Class UID	Transfer Syntax Name	Transfer Syntax UID
MR Image Storage	1.2.840.10008.5.1.4.1.1.4	Implicit VR Little Endian Explicit VR Little Endian JPEG Lossy Baseline (Process 1) JPEG Lossless Non-Hierarchical (Process 14)	1.2.840.10008.1.2 1.2.840.10008.1.2.1 1.2.840.10008.1.2.4.50 1.2.840.10008.1.2.4.57
Nuclear Medicine Image Storage (Retired)	1.2.840.10008.5.1.4.1.1.5	Implicit VR Little Endian Explicit VR Little Endian JPEG Lossy Baseline (Process 1) JPEG Lossless Non-Hierarchical (Process 14)	1.2.840.10008.1.2 1.2.840.10008.1.2.1 1.2.840.10008.1.2.4.50 1.2.840.10008.1.2.4.57
Ultrasound Image Storage (Retired)	1.2.840.10008.5.1.4.1.1.6	Implicit VR Little Endian Explicit VR Little Endian JPEG Lossy Baseline (Process 1) JPEG Lossless Non-Hierarchical (Process 14)	1.2.840.10008.1.2 1.2.840.10008.1.2.1 1.2.840.10008.1.2.4.50 1.2.840.10008.1.2.4.57
Ultrasound Image Storage	1.2.840.10008.5.1.4.1.1.6.1	Implicit VR Little Endian Explicit VR Little Endian JPEG Lossy Baseline (Process 1) JPEG Lossless Non-Hierarchical (Process 14)	1.2.840.10008.1.2 1.2.840.10008.1.2.1 1.2.840.10008.1.2.4.50 1.2.840.10008.1.2.4.57
Secondary Capture Image Storage	1.2.840.10008.5.1.4.1.1.7	Implicit VR Little Endian Explicit VR Little Endian JPEG Lossy Baseline (Process 1) JPEG Lossless Non-Hierarchical (Process 14)	1.2.840.10008.1.2 1.2.840.10008.1.2.1 1.2.840.10008.1.2.4.50 1.2.840.10008.1.2.4.57
Multi-frame Grayscale Byte Secondary Capture Image Storage	1.2.840.10008.5.1.4.1.1.7.2	Implicit VR Little Endian Explicit VR Little Endian JPEG Lossy Baseline (Process 1) JPEG Lossless Non-Hierarchical (Process 14)	1.2.840.10008.1.2 1.2.840.10008.1.2.1 1.2.840.10008.1.2.4.50 1.2.840.10008.1.2.4.57
Multi-frame Grayscale Word Secondary Capture Image Storage	1.2.840.10008.5.1.4.1.1.7.3	Implicit VR Little Endian Explicit VR Little Endian JPEG Lossy Baseline (Process 1) JPEG Lossless Non-Hierarchical (Process 14)	1.2.840.10008.1.2 1.2.840.10008.1.2.1 1.2.840.10008.1.2.4.50 1.2.840.10008.1.2.4.57
Multi-frame True Color Secondary Capture Image Storage	1.2.840.10008.5.1.4.1.1.7.4	Implicit VR Little Endian Explicit VR Little Endian JPEG Lossy Baseline (Process 1) JPEG Lossless Non-Hierarchical (Process 14)	1.2.840.10008.1.2 1.2.840.10008.1.2.1 1.2.840.10008.1.2.4.50 1.2.840.10008.1.2.4.57

SOP Class	SOP Class UID	Transfer Syntax Name	Transfer Syntax UID
X-Ray Angiographic Image Storage	1.2.840.10008.5.1.4.1.1.12.1	Implicit VR Little Endian Explicit VR Little Endian JPEG Lossy Baseline (Process 1) JPEG Lossless Non-Hierarchical (Process 14)	1.2.840.10008.1.2 1.2.840.10008.1.2.1 1.2.840.10008.1.2.4.50 1.2.840.10008.1.2.4.57
X-Ray Radiofluoroscopic Image Storage	1.2.840.10008.5.1.4.1.1.12.2	Implicit VR Little Endian Explicit VR Little Endian JPEG Lossy Baseline (Process 1) JPEG Lossless Non-Hierarchical (Process 14)	1.2.840.10008.1.2 1.2.840.10008.1.2.1 1.2.840.10008.1.2.4.50 1.2.840.10008.1.2.4.57
Nuclear Medicine Image Storage	1.2.840.10008.5.1.4.1.1.20	Implicit VR Little Endian Explicit VR Little Endian JPEG Lossy Baseline (Process 1) JPEG Lossless Non-Hierarchical (Process 14)	1.2.840.10008.1.2 1.2.840.10008.1.2.1 1.2.840.10008.1.2.4.50 1.2.840.10008.1.2.4.57
VL Image Storage (Retired)	1.2.840.10008.5.1.4.1.1.77.1	Implicit VR Little Endian Explicit VR Little Endian JPEG Lossy Baseline (Process 1) JPEG Lossless Non-Hierarchical (Process 14)	1.2.840.10008.1.2 1.2.840.10008.1.2.1 1.2.840.10008.1.2.4.50 1.2.840.10008.1.2.4.57
VL Endoscopic Image Storage SOP Class	1.2.840.10008.5.1.4.1.1.77.1.1	Implicit VR Little Endian Explicit VR Little Endian JPEG Lossy Baseline (Process 1) JPEG Lossless Non-Hierarchical (Process 14)	1.2.840.10008.1.2 1.2.840.10008.1.2.1 1.2.840.10008.1.2.4.50 1.2.840.10008.1.2.4.57
VL Microscopic Image Storage SOP Class	1.2.840.10008.5.1.4.1.1.77.1.2	Implicit VR Little Endian Explicit VR Little Endian JPEG Lossy Baseline (Process 1) JPEG Lossless Non-Hierarchical (Process 14)	1.2.840.10008.1.2 1.2.840.10008.1.2.1 1.2.840.10008.1.2.4.50 1.2.840.10008.1.2.4.57
VL Slide-Coordinates Microscopic Image Storage	1.2.840.10008.5.1.4.1.1.77.1.3	Implicit VR Little Endian Explicit VR Little Endian JPEG Lossy Baseline (Process 1) JPEG Lossless Non-Hierarchical (Process 14)	1.2.840.10008.1.2 1.2.840.10008.1.2.1 1.2.840.10008.1.2.4.50 1.2.840.10008.1.2.4.57
VL Photographic Image Storage SOP Class	1.2.840.10008.5.1.4.1.1.77.1.4	Implicit VR Little Endian Explicit VR Little Endian JPEG Lossy Baseline (Process 1) JPEG Lossless Non-Hierarchical (Process 14)	1.2.840.10008.1.2 1.2.840.10008.1.2.1 1.2.840.10008.1.2.4.50 1.2.840.10008.1.2.4.57

MEDIA INTERCHANGE

SOP Class	SOP Class UID	Transfer Syntax Name	Transfer Syntax UID
Ophthalmic Photography 8 Bit Image Storage	1.2.840.10008.5.1.4.1.1.77.1.5.1	Implicit VR Little Endian Explicit VR Little Endian JPEG Lossy Baseline (Process 1) JPEG Lossless Non-Hierarchical (Process 14)	1.2.840.10008.1.2 1.2.840.10008.1.2.1 1.2.840.10008.1.2.4.50 1.2.840.10008.1.2.4.57
Ophthalmic Photography 16 Bit Image Storage	1.2.840.10008.5.1.4.1.1.77.1.5.2	Implicit VR Little Endian Explicit VR Little Endian JPEG Lossy Baseline (Process 1) JPEG Lossless Non-Hierarchical (Process 14)	1.2.840.10008.1.2 1.2.840.10008.1.2.1 1.2.840.10008.1.2.4.50 1.2.840.10008.1.2.4.57
VL Multi-frame Image Storage (Retired)	1.2.840.10008.5.1.4.1.1.77.2	Implicit VR Little Endian Explicit VR Little Endian JPEG Lossy Baseline (Process 1) JPEG Lossless Non-Hierarchical (Process 14)	1.2.840.10008.1.2 1.2.840.10008.1.2.1 1.2.840.10008.1.2.4.50 1.2.840.10008.1.2.4.57
Encapsulated PDF Storage SOP Class	1.2.840.10008.5.1.4.1.1.104.1	Implicit VR Little Endian Explicit VR Little Endian	1.2.840.10008.1.2 1.2.840.10008.1.2.1
Positron Emission Tomography Image Storage	1.2.840.10008.5.1.4.1.1.128	Implicit VR Little Endian Explicit VR Little Endian JPEG Lossy Baseline (Process 1) JPEG Lossless Non-Hierarchical (Process 14)	1.2.840.10008.1.2 1.2.840.10008.1.2.1 1.2.840.10008.1.2.4.50 1.2.840.10008.1.2.4.57
RT Image Storage	1.2.840.10008.5.1.4.1.1.481.1	Implicit VR Little Endian Explicit VR Little Endian JPEG Lossy Baseline (Process 1) JPEG Lossless Non-Hierarchical (Process 14)	1.2.840.10008.1.2 1.2.840.10008.1.2.1 1.2.840.10008.1.2.4.50 1.2.840.10008.1.2.4.57

3.2.1.2.1.2 Application Profile Specific Conformance

There are no extensions or specializations.

3.3 Augmented and Private Application Profiles

There are no augmented or private application profiles.

3.4 Media Configuration

None.

4 SUPPORT OF CHARACTER SETS

Only the default ISO-IR 6 character set is supported. Extended character sets are not supported.

SUPPORT OF CHARACTER SETS

5 SECURITY

5.1 Security Profiles

No DICOM security features are implemented.

5.2 Association-level Security

Only requests from AEs configured by an authorized user are accepted.

5.3 Application-level Security

Application-level security is enforced through logins into the VistA HIS.

ANNEXES

Annexes A.1 – A.6 are currently under development and will be available at a later date.